

Features

- Low drain-source on-resistance: $R_{DS(ON)}=0.22\Omega$ (typ)
- Easy to control gate switching
- Enhancement mode: $V_{th} = 2.0$ to $4.0V$
- 100% avalanche tested
- Built-in ESD Diode
- RoHS compliant

Key Performance Parameters



Parameter	Value	Unit
$V_{DS} @ T_{j,max}$	800	V
$R_{DS(ON),max}$	250	m Ω
I_D	18	A
$Q_{g,typ}$	43	nC
I_{DM}	54	A

Applications

- Switch Mode Power Supply (SMPS)
- TV power & LED Lighting Power
- AC to DC Converters
- Telecom

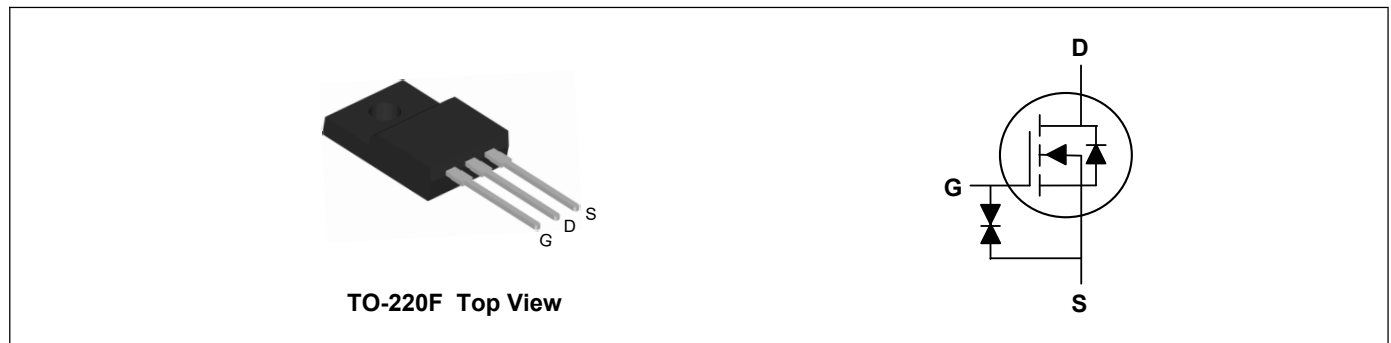

Absolute Maximum Ratings($T_C=25^\circ C$, unless otherwise noted)

Parameter	Symbol	Value	Unit
Drain-Source Voltage	V_{DS}	800	V
Gate-Source Voltage	V_{GS}	± 30	V
Continuous Drain Current ¹	$I_D @ T_C=25^\circ C$	18	A
Continuous Drain Current ¹	$I_D @ T_C=100^\circ C$	11.4	A
Pulsed Drain Current ²	I_{DM}	54	A
Single Pulse Avalanche Energy ⁴	EAS	246	mJ
Avalanche Current	I_{AS}	2.4	A
MOSFET dv/dt ruggedness, $V_{DS} = 0 \dots 400V$	dv/dt	50	V/ns
Reverse diode dv/dt ³ $V_{DS}=0 \dots 400V, I_{DS} \leq I_D$		15	
Total Power Dissipation ($T_C=25^\circ C$)	P_D	33	W
Storage Temperature Range	T_{STG}	-55 to 150	$^\circ C$
Operating Junction Temperature Range	T_J	-55 to 150	$^\circ C$

Thermal Characteristics

Parameter	Symbol	Value	Unit
Thermal Resistance Junction-Ambient (Max)	$R_{\theta JA}$	80	$^\circ C/W$
Thermal Resistance Junction-Case (Max)	$R_{\theta JC}$	3.74	$^\circ C/W$

Electrical Characteristics ($T_J=25^{\circ}\text{C}$, unless otherwise noted)

Parameter	Symbol	Conditions	Min	Typ	Max	Unit
Drain-Source Breakdown Voltage	BV_{DSS}	$V_{GS}=0V, I_D=1mA$	800	---	---	V
Static Drain-Source On-Resistance	$R_{DS(ON)}$	$V_{GS}=10V, I_D=5.3A$	---	220	250	$m\Omega$
Gate Threshold Voltage	$V_{GS(th)}$	$V_{GS}=V_{DS}, I_D=220\mu A$	2.0	---	4.0	V
Drain-Source Leakage Current	I_{DSS}	$V_{DS}=800V, V_{GS}=0V, T_J=25^{\circ}\text{C}$	---	---	1	μA
		$V_{DS}=800V, V_{GS}=0V, T_J=150^{\circ}\text{C}$	---	---	100	μA
Gate-Source Leakage Current	I_{GSS}	$V_{GS}=\pm 30V, V_{DS}=0V$	---	---	± 1	μA
Total Gate Charge	Q_g	$V_{DS}=640V, V_{GS}=10V, I_D=9.6A$	---	43	---	nC
Gate-Source Charge	Q_{gs}		---	8.2	---	
Gate-Drain Charge	Q_{gd}		---	12	---	
Turn-On Delay Time	$T_{d(on)}$	$V_{DS}=400V, R_G=25\Omega, I_D=9.6A$	---	41	---	ns
Rise Time	T_r		---	24	---	
Turn-Off Delay Time	$T_{d(off)}$		---	179	---	
Fall Time	T_f		---	17	---	
Input Capacitance	C_{iss}	$V_{DS}=500V, V_{GS}=0V, f=1MHz$	---	2000	---	μF
Output Capacitance	C_{oss}		---	33	---	
Reverse Transfer Capacitance	C_{rss}		---	3.2	---	

Drain-Source Diode Characteristics

Parameter	Symbol	Conditions	Min	Typ	Max	Unit
Continuous Source Current	I_S	$T_C=25^{\circ}\text{C}$	---	---	18	A
Pulsed Source Current	I_{SM}		---	---	54	A
Diode Forward Voltage	V_{SD}	$V_G=0V, I_S=9.6A, T_J=25^{\circ}\text{C}$	---	---	1.3	V
Reverse Recovery Time	t_{rr}	$V_R=400V, I_F=9.6A, di_F/dt=100A/\mu s$	---	365	---	ns
Reverse Recovery Charge	Q_{rr}		---	4.6	---	μC

Note:

- Limited by $T_{j,max}$. Maximum Duty Cycle $D = 0.50$
- Pulse width t_p limited by $T_{j,max}$
- Identical low side and high side switch with identical R_G
- $V_{DD}=50V, R_G=25\Omega, I_{AS}=2.4A$

Handbook 7 \ UFUWYf]gh]Vg

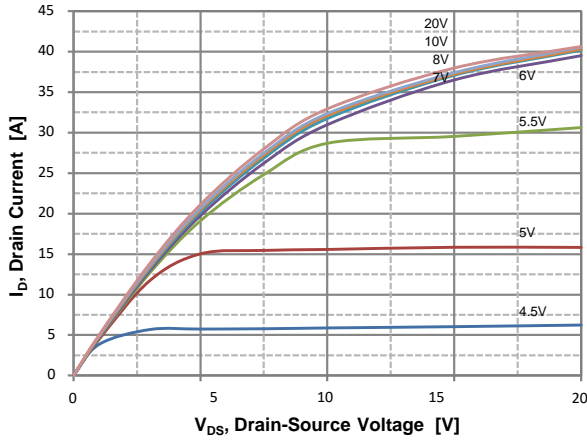

Figure 1. On Region Characteristics

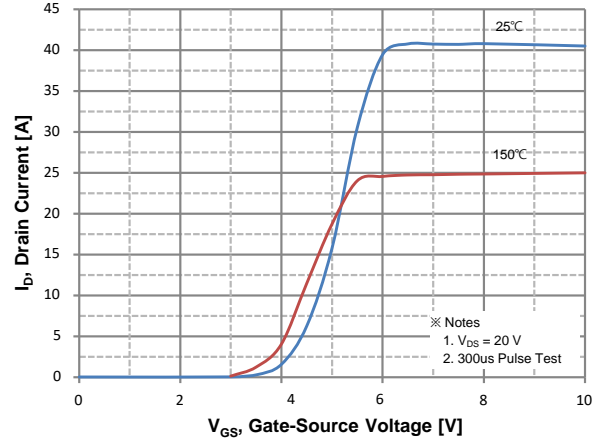

Figure 2. Transfer Characteristics

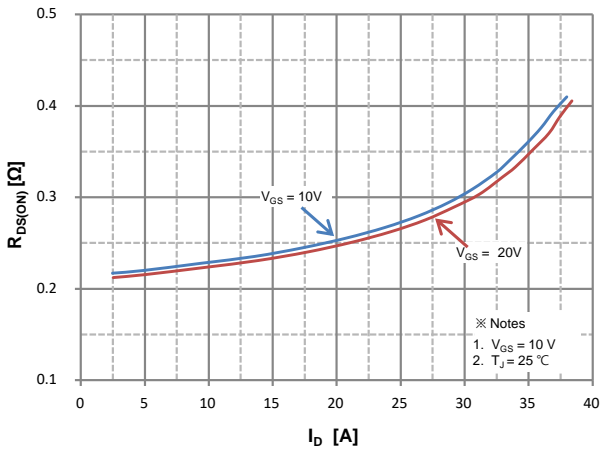

Figure 3. On Resistance Variation vs Drain Current and Gate Voltage

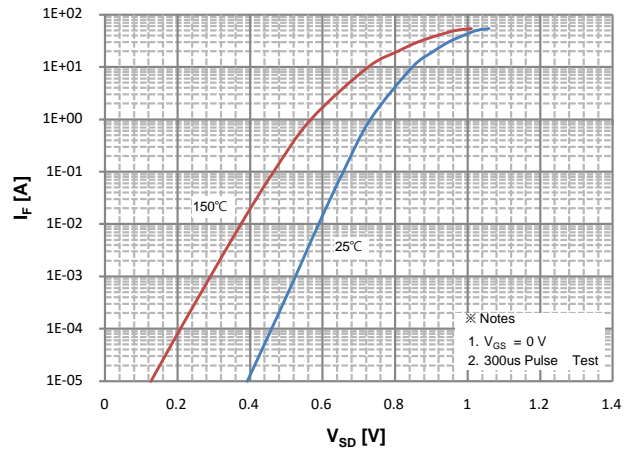

Figure 4. Body Diode Forward Voltage Variation with Source Current and Temperature

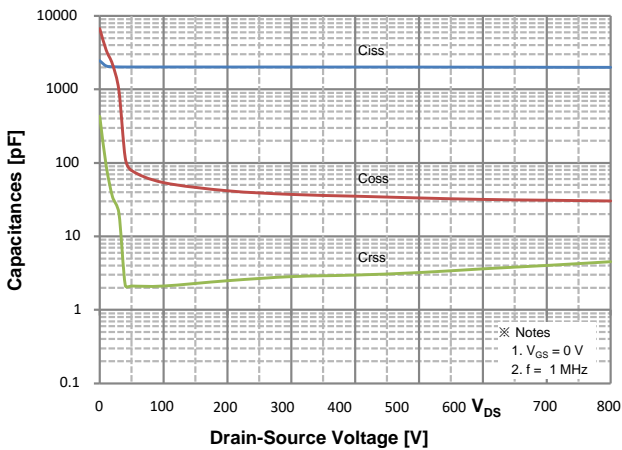

Figure 5. Capacitance Characteristics

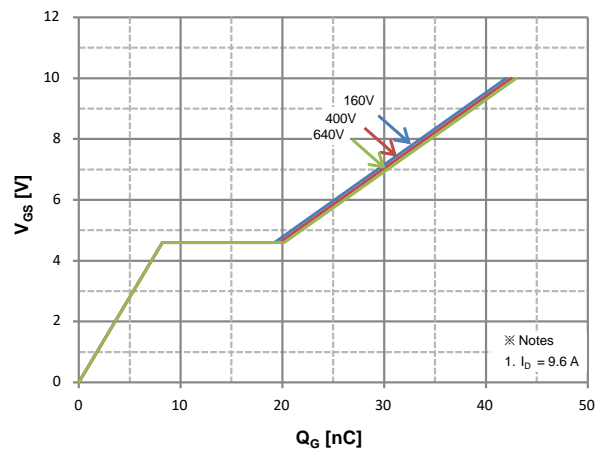

Figure 6. Gate Charge Characteristics

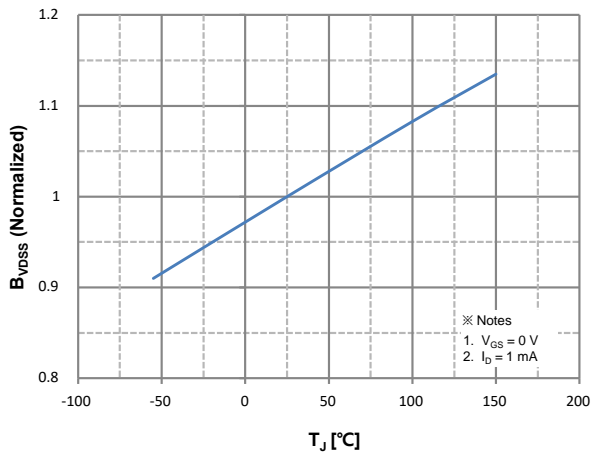

Figure 7. Breakdown Voltage Variation vs. Temperature

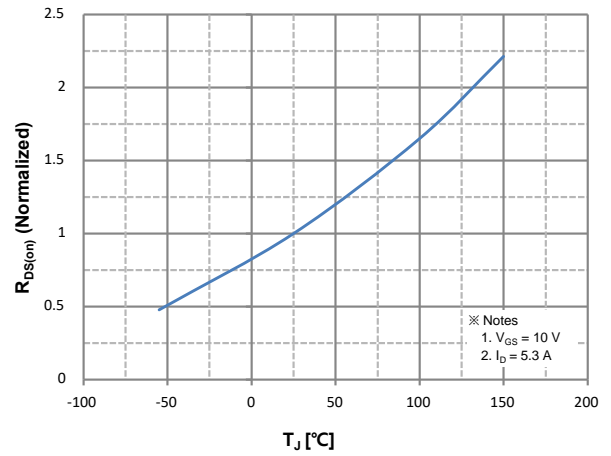

Figure 8. On-Resistance Variation vs. Temperature

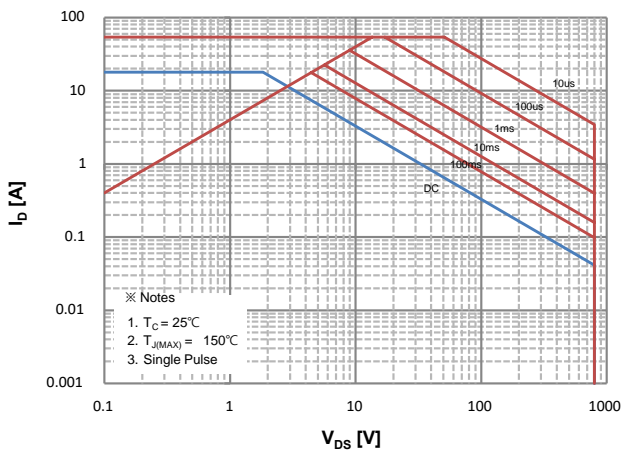

Figure 9. Maximum Safe Operating Area

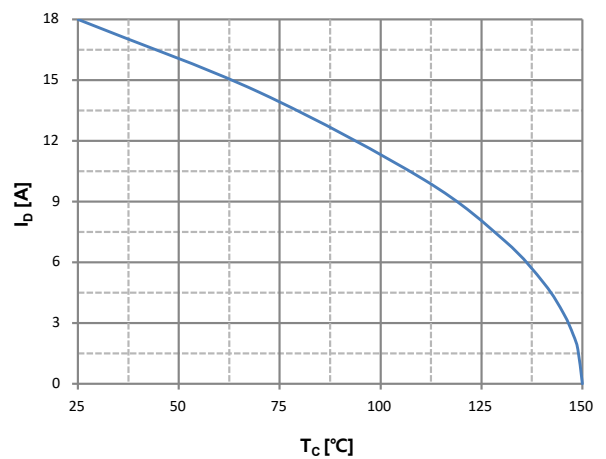

Figure 10. Maximum Drain Current vs. Case Temperature

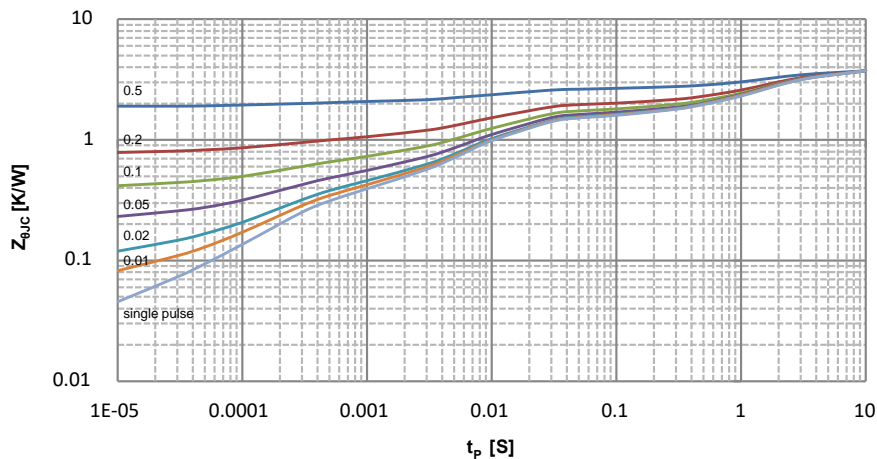
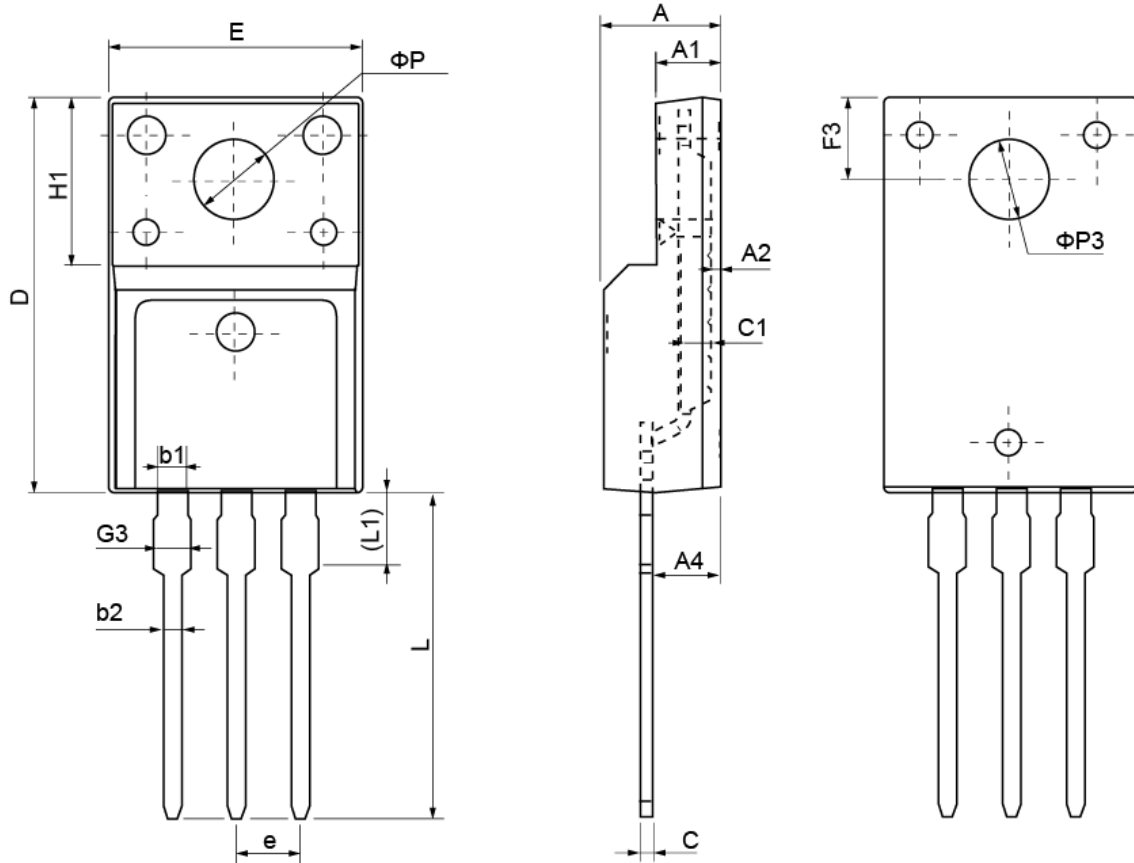

Figure 11. Transient Thermal Response Curve

TO-220F Package Outline Dimensions



Symbol	Dimensions (unit:mm)			Symbol	Dimensions (unit:mm)		
	Min	Typ	Max		Min	Typ	Max
A	4.40	4.70	5.00	H1	6.70 REF		
A1	2.30	2.55	2.80	L	12.30	12.98	13.30
A2	0.30	0.50	0.70	L1	2.95	3.10	3.50
A4	2.45	2.80	3.05	φ P	3.03	3.20	3.50
c	0.30	0.50	0.70	φ P3	3.15	3.45	3.65
c1	1.20	1.30	1.40	b1	1.10	1.30	1.45
D	15.40	15.90	16.40	b2	0.60	0.80	1.00
E	9.86	10.16	10.46	F3	3.05	3.30	3.55
e	2.54 BSC			G3	1.15	1.35	1.55