

Features

- Advanced Shield Gate Trench technology
- Super Low Gate Charge
- High-Speed Switching
- 100% EAS Guaranteed
- Green Device Available

Applications

- High Frequency Point-of-Load, Synchronous Buck Converter
- Networking DC-DC Power System
- Load Switch

Product Summary



V_{DS}	85	V
I_D	120	A
$R_{DS(ON)}$ (at $V_{GS}=10V$)	5.6	m Ω

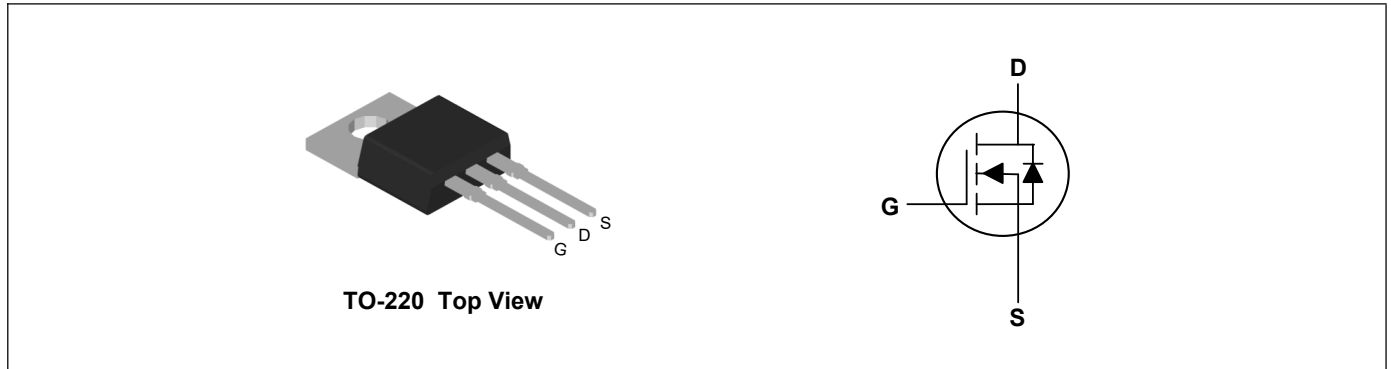

Absolute Maximum Ratings($T_c=25^\circ C$, unless otherwise noted)

Parameter	Symbol	Rating	Units
Drain-Source Voltage	V_{DS}	85	V
Gate-Source Voltage	V_{GS}	± 20	V
Continuous Drain Current ¹	I_D	120	A
Continuous Drain Current ¹	I_D	65	A
	$T_c=100^\circ C$		
Pulsed Drain Current ²	I_{DM}	360	A
Single Pulse Avalanche Energy ³	E_{AS}	780	mJ
Total Power Dissipation	P_D	180	W
Storage Temperature Range	T_{STG}	-55 to 175	$^\circ C$
Operating Junction Temperature Range	T_J	-55 to 175	$^\circ C$

Thermal Characteristics

Parameter	Symbol	Typ	Max	Unit
Thermal Resistance Junction-Ambient ¹	$R_{\theta JA}$	---	62	$^\circ C/W$
Thermal Resistance Junction-Case ¹	$R_{\theta JC}$	---	0.95	$^\circ C/W$

Electrical Characteristics ($T_J=25^{\circ}\text{C}$, unless otherwise noted)

Parameter	Symbol	Conditions	Min	Typ	Max	Unit
Drain-Source Breakdown Voltage	BV_{DSS}	$V_{GS}=0V, I_D=250\mu A$	85	---	---	V
Static Drain-Source On-Resistance	$R_{DS(ON)}$	$V_{GS}=10V, I_D=50A$	---	4.5	5.6	m Ω
Gate Threshold Voltage	$V_{GS(th)}$	$V_{GS}=V_{DS}, I_D=250\mu A$	2	3	4	V
Drain-Source Leakage Current	I_{DSS}	$V_{DS}=80V, V_{GS}=0V$	---	---	1	μA
Gate-Source Leakage Current	I_{GSS}	$V_{GS}=\pm 20V, V_{DS}=0V$	---	---	± 100	nA
Gate Resistance	R_g	$V_{DS}=0V, V_{GS}=0V, f=1\text{MHz}$	---	2	---	Ω
Total Gate Charge	Q_g	$V_{DS}=40V, V_{GS}=10V, I_D=50A$	---	44	---	nC
Gate-Source Charge	Q_{gs}		---	14	---	
Gate-Drain Charge	Q_{gd}		---	11	---	
Turn-On Delay Time	$T_{d(on)}$	$V_{DD}=40V, V_{GS}=10V, R_G=2.7\Omega, I_D=10A$	---	14	---	ns
Rise Time	T_r		---	23	---	
Turn-Off Delay Time	$T_{d(off)}$		---	36	---	
Fall Time	T_f		---	16	---	
Input Capacitance	C_{iss}	$V_{DS}=42.5V, V_{GS}=0V, f=1\text{MHz}$	---	3900	---	pF
Output Capacitance	C_{oss}		---	650	---	
Reverse Transfer Capacitance	C_{rss}		---	20	---	

Drain-Source Diode Characteristics

Parameter	Symbol	Conditions	Min	Typ	Max	Unit
Continuous Source Current ¹	I_S		---	---	120	A
Diode Forward Voltage ²	V_{SD}	$V_{GS}=0V, I_S=10A, T_J=25^{\circ}\text{C}$	---	---	1.2	V
Reverse Recovery Time	t_{rr}	$I_S=50A$ $di/dt=100A/\mu s, T_J=25^{\circ}\text{C}$	---	38	---	nS
Reverse Recovery Charge	Q_{rr}		---	45	---	nC

Note:

- 1.The data tested by surface mounted on a 1 inch² FR-4 board with 2OZ copper.
- 2.The data tested by pulsed , pulse width $\leq 300\mu s$, duty cycle $\leq 2\%$
- 3.The EAS data shows Max. rating . The test condition is $V_{DD}=48V, R_G=50\Omega$

Typical Characteristics

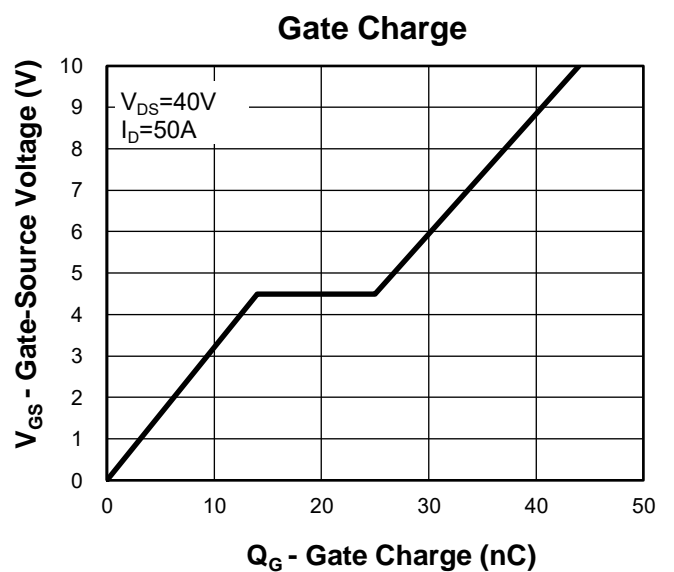
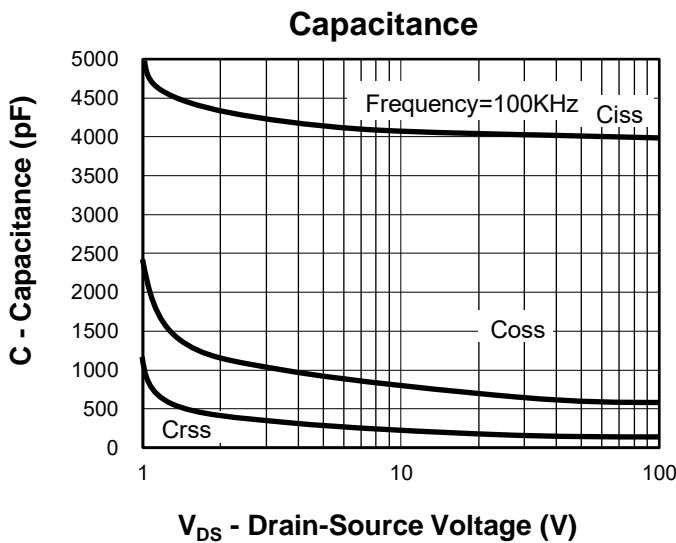
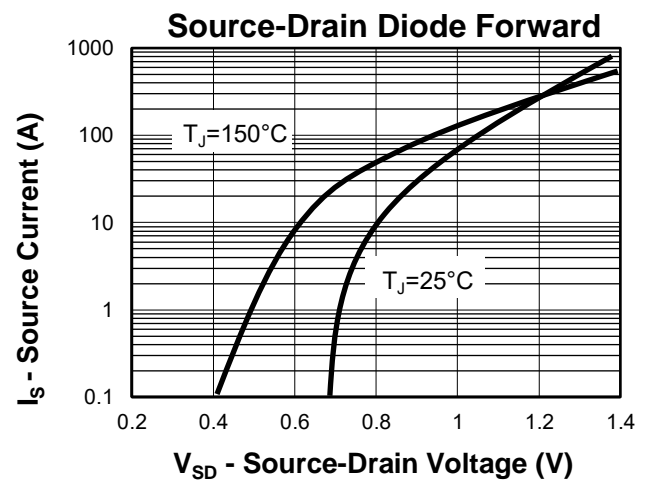
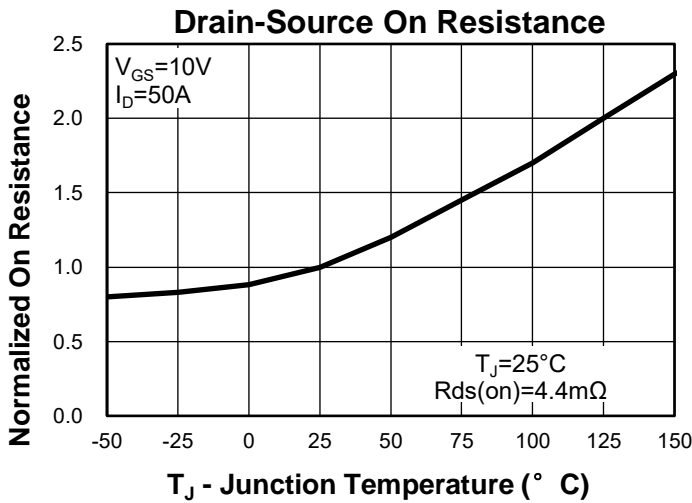
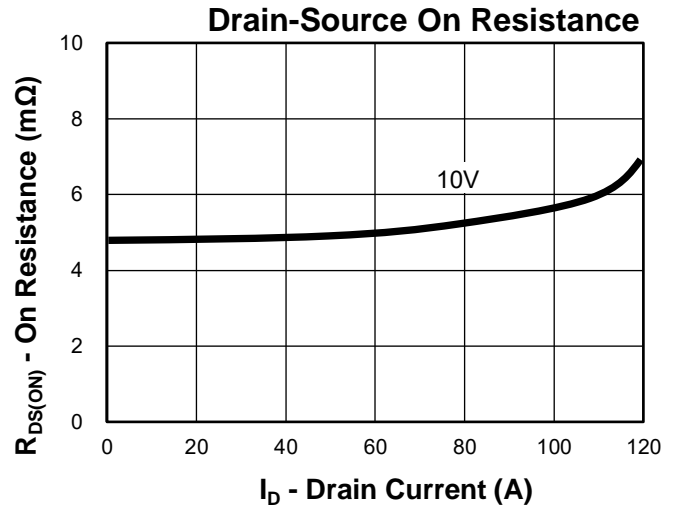
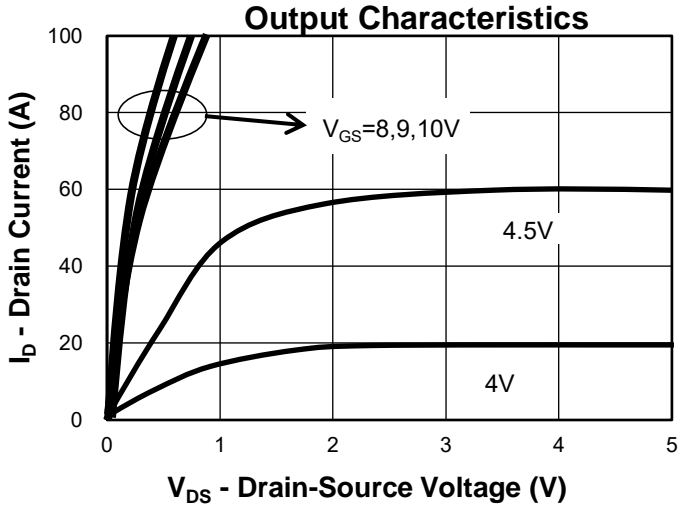

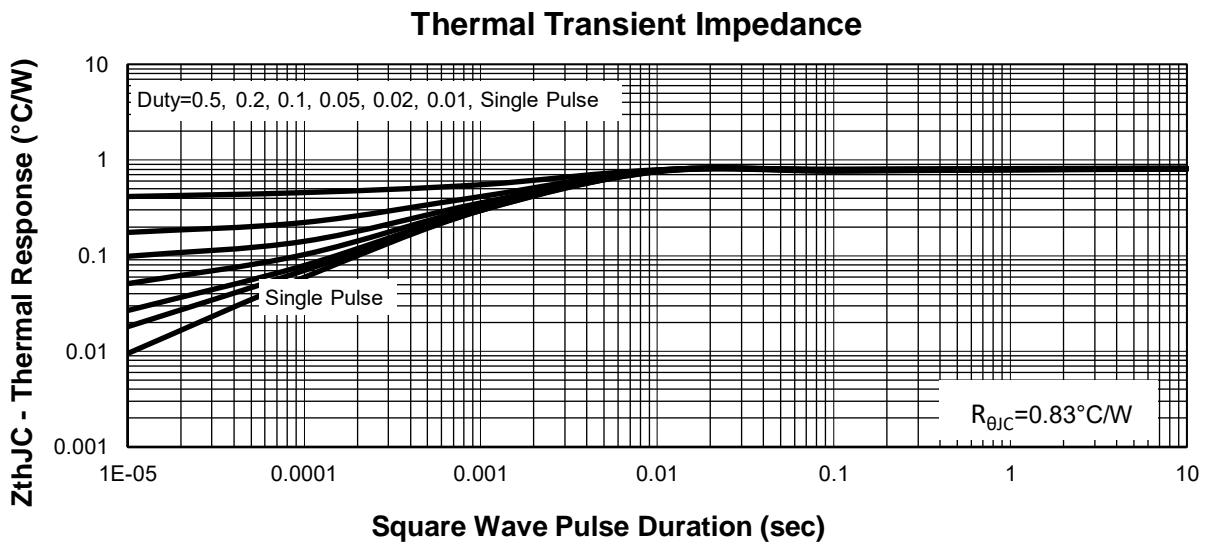
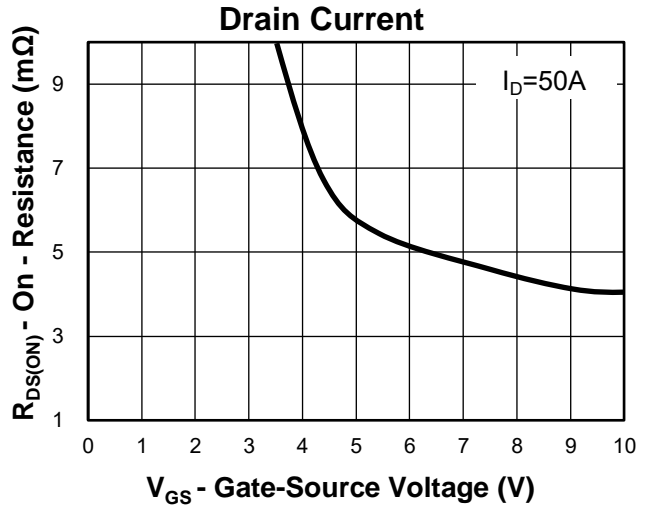
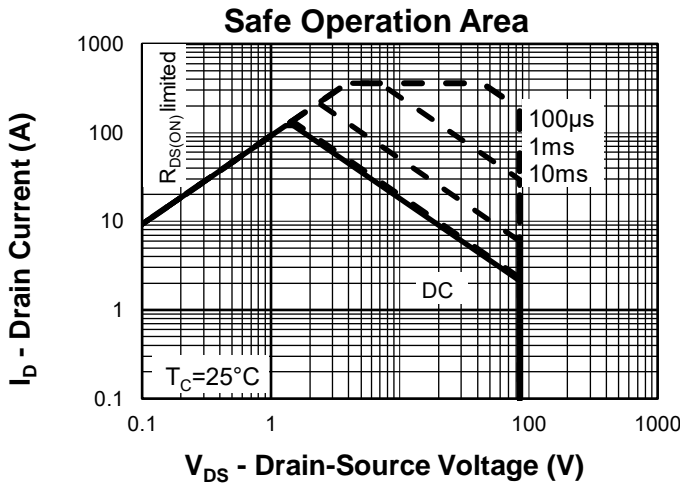
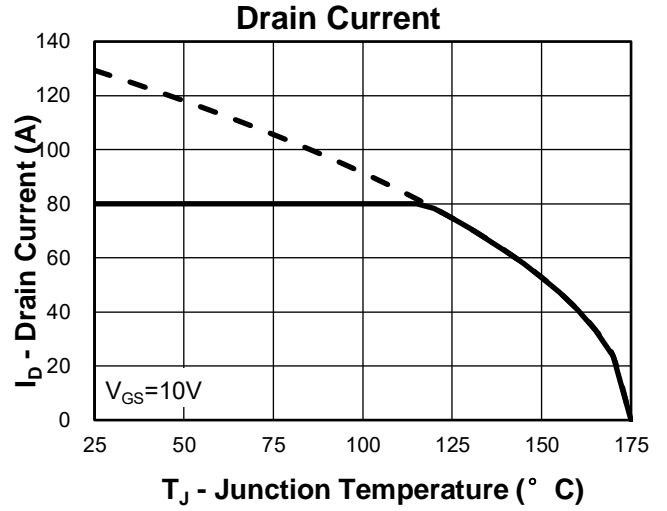
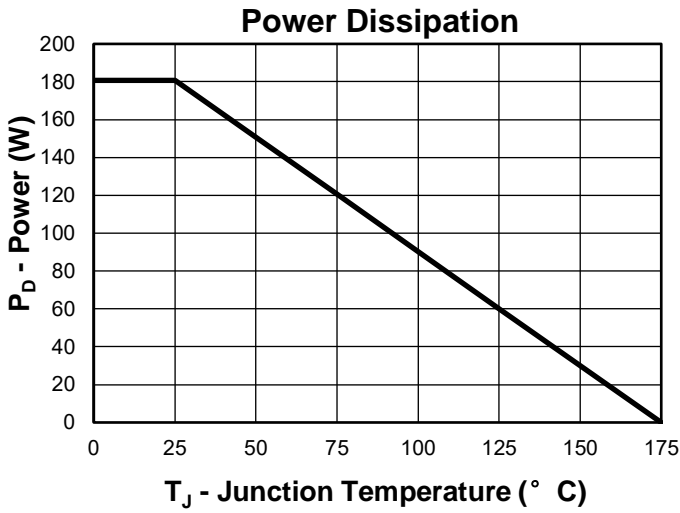

TO-220 Package Outline Dimensions

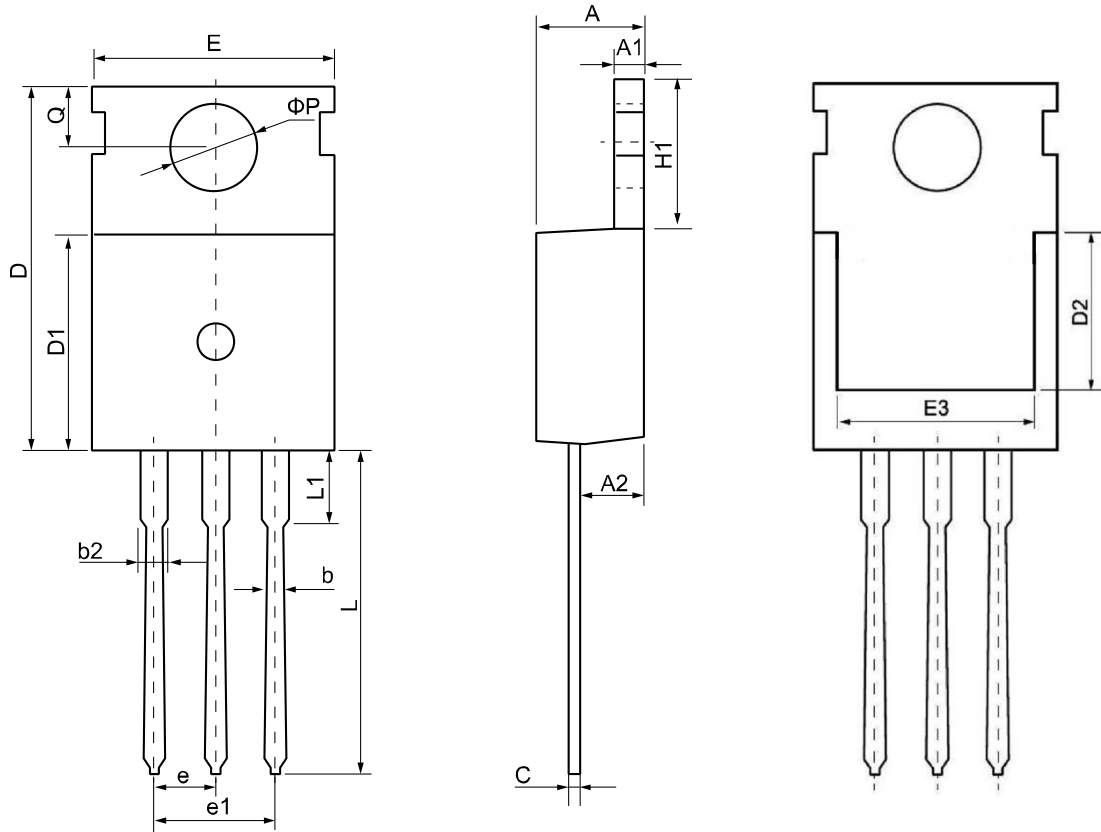

Symbol	Dimensions (unit:mm)			Symbol	Dimensions (unit:mm)		
	Min	Typ	Max		Min	Typ	Max
A	4.30	4.55	4.75	E	9.65	10.00	10.25
A1	1.15	1.30	1.45	E3	7.00	--	--
A2	2.20	2.40	2.60	e	2.54 BSC		
b	0.70	0.80	0.95	e1	5.08 BSC		
b2	1.17	1.27	1.47	H1	6.30	6.50	6.80
c	0.40	0.50	0.65	L	12.70	13.50	14.10
D	15.30	15.60	15.90	L1	--	3.20	3.95
D1	8.90	9.10	9.35	ϕP	3.40	3.60	3.80
D2	5.50	--	--	Q	2.60	2.80	3.00