

Features

- Advanced high cell density Trench technology
- Super Low Gate Charge
- Excellent CdV/dt effect decline
- Green Device Available

Product Summary



V_{DS}	40	V
I_D	75	A
$R_{DS(ON)}$ (at $V_{GS}=10V$)	6.5	m Ω
$R_{DS(ON)}$ (at $V_{GS}=4.5V$)	9	m Ω

Applications

- High Frequency Point-of-Load, Synchronous Buck Converter
- Networking DC-DC Power System
- Load Switch, LED applications

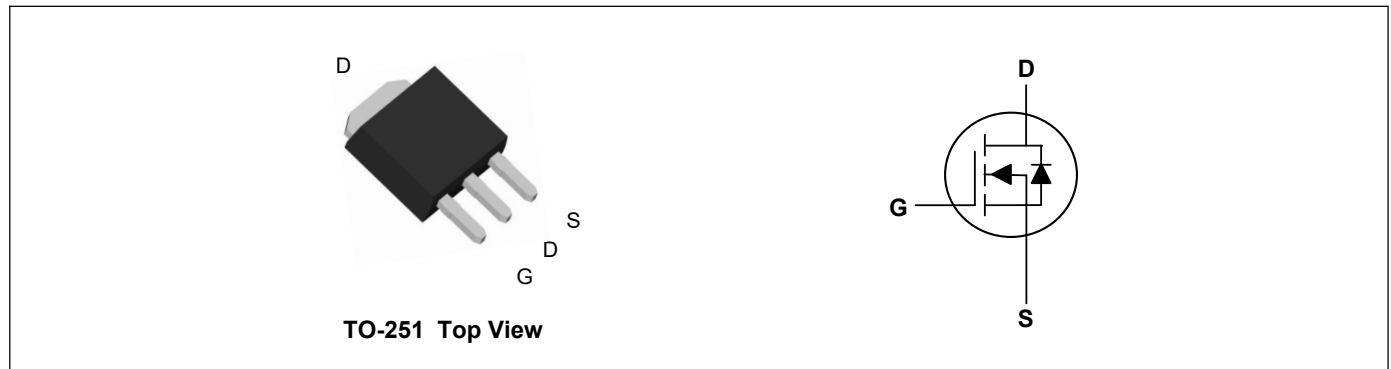

Absolute Maximum Ratings ($T_C=25^{\circ}C$, unless otherwise noted)

Parameter	Symbol	Rating	Units
Drain-Source Voltage	V_{DS}	40	V
Gate-Source Voltage	V_{GS}	± 20	V
Continuous Drain Current ¹	$I_D@T_C=25^{\circ}C$	75	A
Continuous Drain Current ¹	$I_D@T_C=100^{\circ}C$	58	A
Pulsed Drain Current ²	I_{DM}	150	A
Single Pulse Avalanche Energy ³	EAS	110.5	mJ
Avalanche Current	I_{AS}	47	A
Total Power Dissipation ⁴	$P_D@T_C=25^{\circ}C$	52.1	W
Storage Temperature Range	T_{STG}	-55 to 150	$^{\circ}C$
Operating Junction Temperature Range	T_J	-55 to 150	$^{\circ}C$

Thermal Characteristics

Parameter	Symbol	Typ	Max	Unit
Thermal Resistance Junction-Ambient ¹	$R_{\theta JA}$	---	62	$^{\circ}C/W$
Thermal Resistance Junction-Case ¹	$R_{\theta JC}$	---	2.4	$^{\circ}C/W$

Electrical Characteristics (T_J=25°C, unless otherwise noted)

Parameter	Symbol	Conditions	Min	Typ	Max	Unit
Drain-Source Breakdown Voltage	BV _{DSS}	V _{GS} =0V, I _D =250uA	40	---	---	V
BV _{DSS} Temperature Coefficient	ΔBV _{DSS} /ΔT _J	Reference to 25°C, I _D =1mA	---	0.034	---	V/°C
Static Drain-Source On-Resistance ²	R _{DS(ON)}	V _{GS} =10V, I _D =15A	---	5.0	6.5	mΩ
		V _{GS} =4.5V, I _D =12A	---	6.7	9	mΩ
Gate Threshold Voltage	V _{GS(th)}	V _{GS} =V _{DS} , I _D =250uA	1.0	1.8	2.5	V
V _{GS(th)} Temperature Coefficient	ΔV _{GS(th)}		---	-5.84	---	mV/°C
Drain-Source Leakage Current	I _{DSS}	V _{DS} =32V, V _{GS} =0V, T _J =25°C	---	---	1	uA
		V _{DS} =32V, V _{GS} =0V, T _J =55°C	---	---	5	uA
Gate-Source Leakage Current	I _{GSS}	V _{GS} =±20V, V _{DS} =0V	---	---	±100	nA
Forward Transconductance	g _{fs}	V _{DS} =5V, I _D =15A	---	27	---	S
Gate Resistance	R _g	V _{DS} =0V, V _{GS} =0V, f=1MHz	---	1.4	---	Ω
Total Gate Charge	Q _g	V _{DS} =20V, V _{GS} =4.5V, I _D =12A	---	28	---	nC
Gate-Source Charge	Q _{gs}		---	7.85	---	
Gate-Drain Charge	Q _{gd}		---	12.5	---	
Turn-On Delay Time	T _{d(on)}	V _{DD} =15V, V _{GS} =10V, R _G =3.3Ω, I _D =1A	---	20.2	---	ns
Rise Time	T _r		---	11.8	---	
Turn-Off Delay Time	T _{d(off)}		---	84.8	---	
Fall Time	T _f		---	8.6	---	
Input Capacitance	C _{iss}	V _{DS} =15V, V _{GS} =0V, f=1MHz	---	3224	---	pF
Output Capacitance	C _{oss}		---	275	---	
Reverse Transfer Capacitance	C _{rss}		---	204	---	

Drain-Source Diode Characteristics

Parameter	Symbol	Conditions	Min	Typ	Max	Unit
Continuous Source Current ¹	I _S	V _G =V _D =0V, Force Current	---	---	75	A
Pulsed Source Current ²	I _{SM}		---	---	150	A
Diode Forward Voltage ²	V _{SD}	V _{GS} =0V, I _S =1A, T _J =25°C	---	---	1	V

Note:

- 1.The data tested by surface mounted on a 1 inch² FR-4 board with 2OZ copper.
- 2.The data tested by pulsed, pulse width ≤ 300us, duty cycle ≤ 2%
- 3.The EAS data shows Max. rating. The test condition is V_{DD}=25V, V_{GS}=10V, L=0.1mH
- 4.The power dissipation is limited by 150°C junction temperature

Typical Characteristics

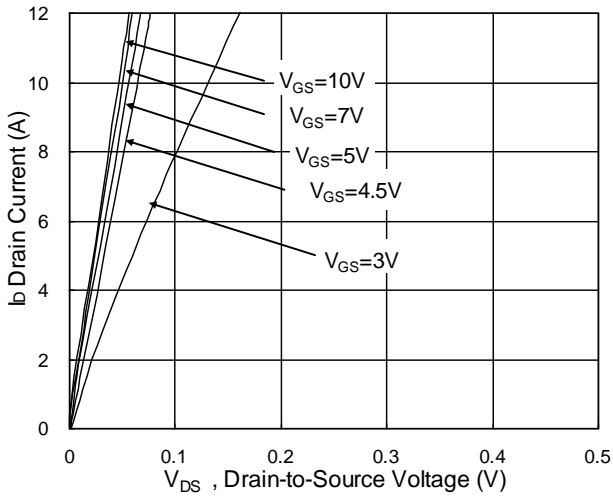

Fig.1 Typical Output Characteristics

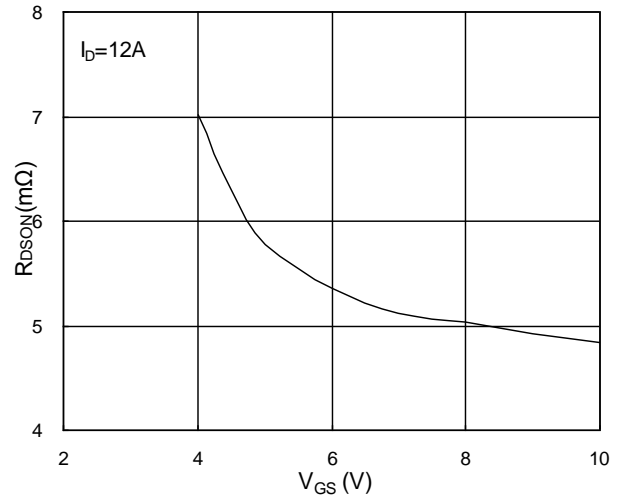

Fig.2 On-Resistance vs. G-S Voltage

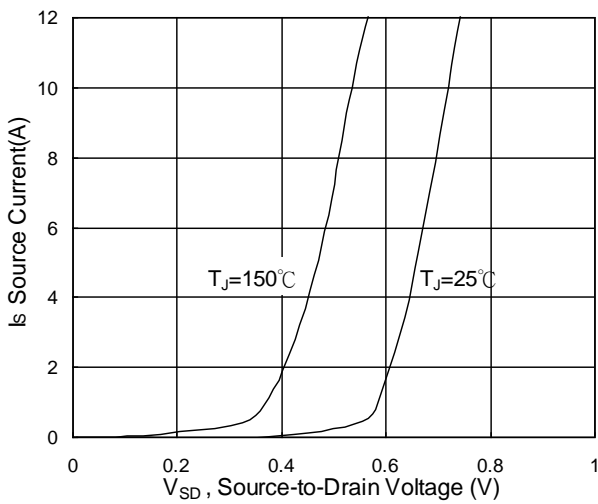

Fig.3 Forward Characteristics Of Reverse

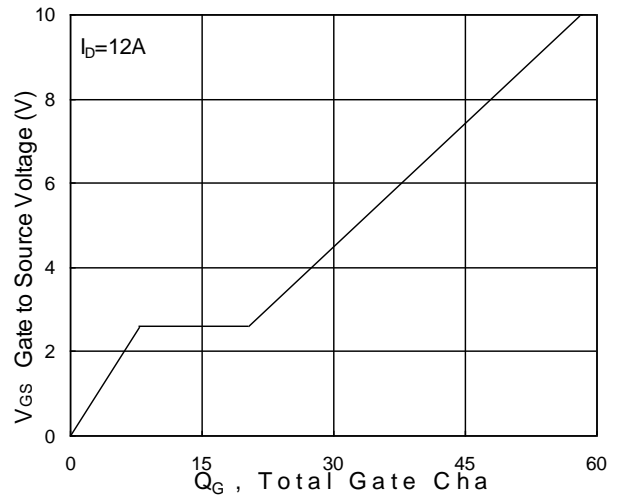

Fig.4 Gate-Charge Characteristics

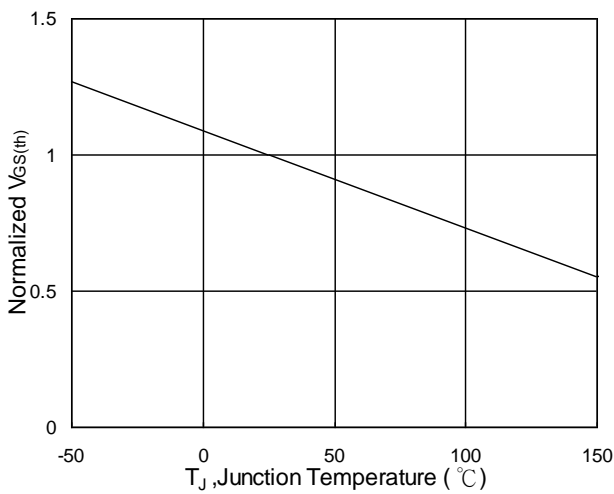

Fig.5 Normalized $V_{GS(th)}$ vs. T_J

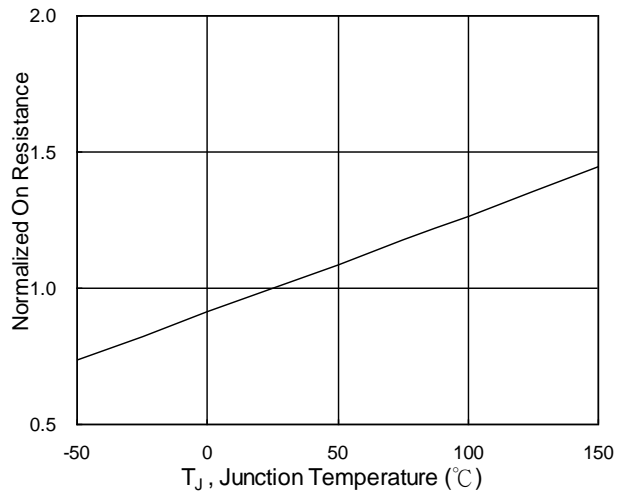

Fig.6 Normalized $R_{DS(on)}$ vs. T_J

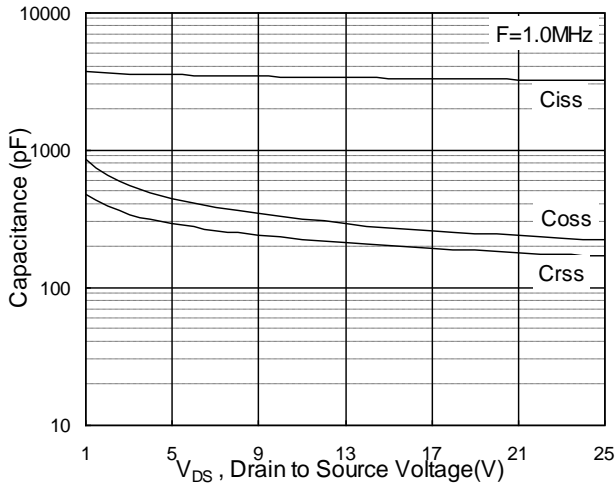

Fig.7 Capacitance

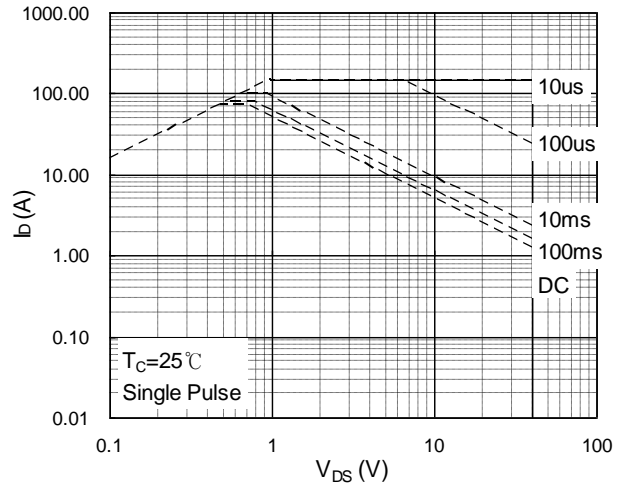

Fig.8 Safe Operating Area

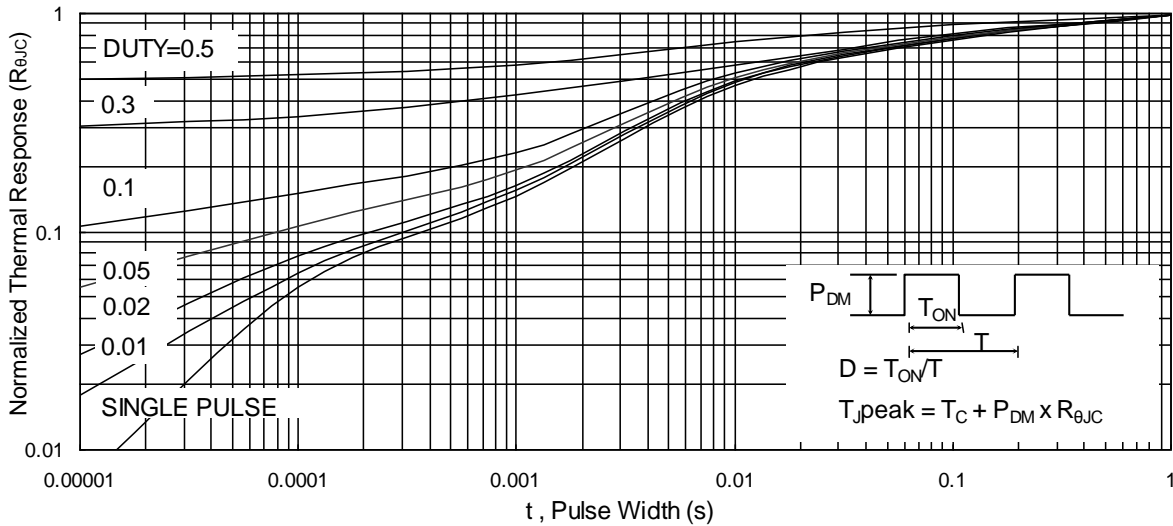

Fig.9 Normalized Maximum Transient Thermal Impedance

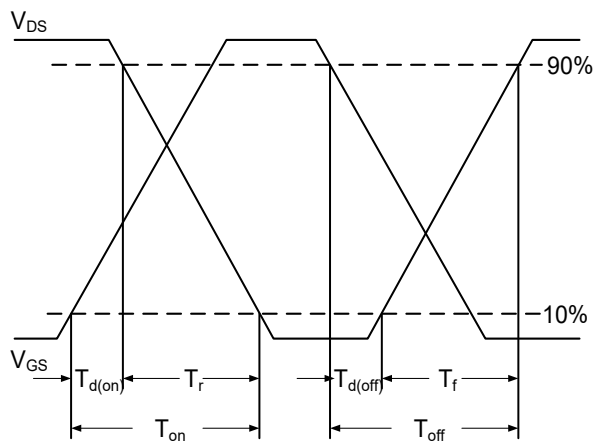

Fig.10 Switching Time Waveform

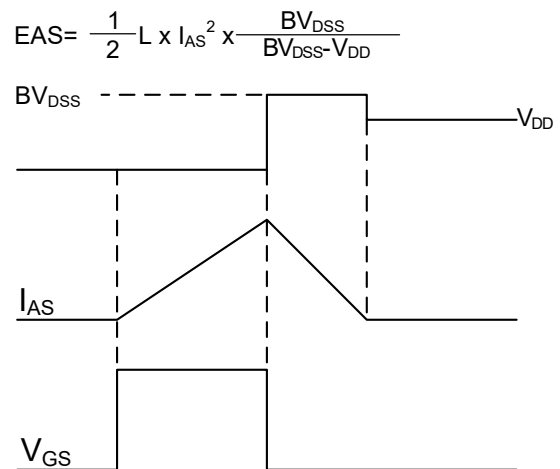
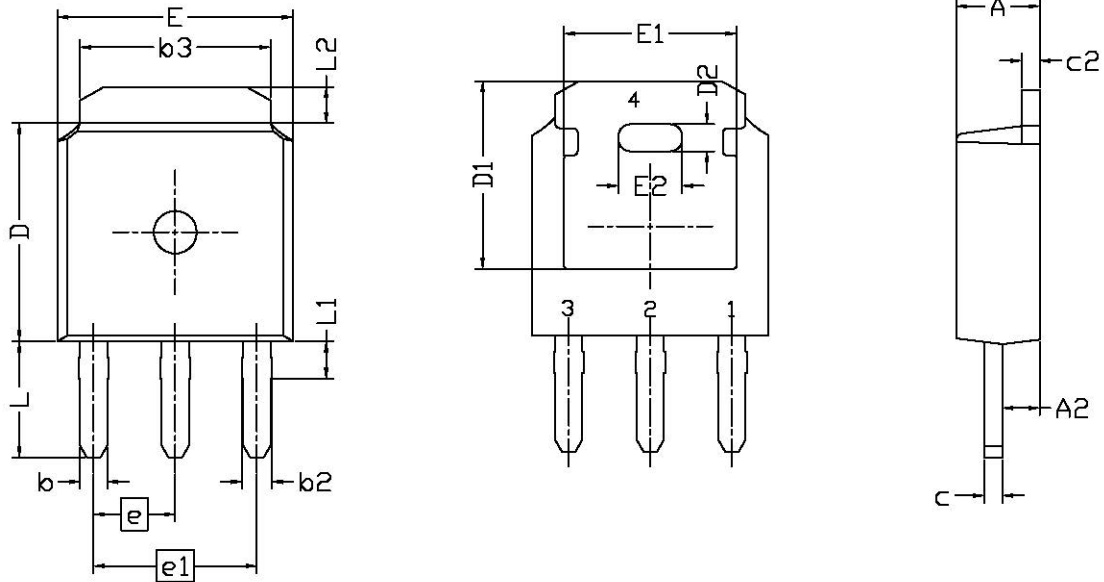

Fig.11 Unclamped Inductive Switching Wave

TO-251 Package Outline Dimensions



Symbol	Dimensions (unit:mm)			Symbol	Dimensions (unit:mm)		
	Min	Typ	Max		Min	Typ	Max
A	2.20	2.30	2.39	A2	0.90	1.00	1.14
b	0.63	0.76	0.85	b2	0.76	0.85	1.05
b3	5.10	5.40	5.60	C	0.46	0.51	0.61
C2	0.46	0.51	0.61	D	5.90	6.10	6.30
D1	5.25 REF			D2	0.508 BSC		
E	6.35	6.55	6.70	E1	5.06 REF		
E2	1.524 BSC			e	2.29 BSC		
e1	4.57 BSC			L	3.70	4.00	4.40
L1	1.15 REF			L2	0.90	1.06	1.20