

Features

- Advanced high cell density Trench technology
- Super Low Gate Charge
- Excellent CdV/dt effect decline
- 100% EAS Guaranteed
- Green Device Available

Product Summary



V_{DS}	30	V
I_D	14	A
$R_{DS(ON)}$ (at $V_{GS}=10V$)	10	m Ω
$R_{DS(ON)}$ (at $V_{GS}=4.5V$)	14	m Ω

Applications

- High Frequency Point-of-Load, Synchronous Buck Converter for MB/NB/UMPC/VGA
- Networking DC-DC Power System
- Load Switch

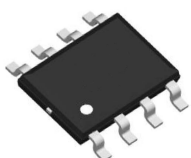

SOP-8 Top View

Top View

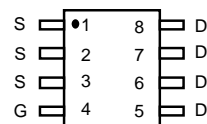

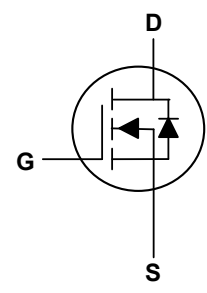

Absolute Maximum Ratings ($T_A=25^{\circ}C$, unless otherwise noted)

Parameter	Symbol	Rating	Units
Drain-Source Voltage	V_{DS}	30	V
Gate-Source Voltage	V_{GS}	± 20	V
Continuous Drain Current, V_{GS} @ 10V ¹	$I_D@T_A=25^{\circ}C$	14	A
Continuous Drain Current, V_{GS} @ 10V ¹	$I_D@T_A=70^{\circ}C$	10	A
Pulsed Drain Current ²	I_{DM}	65	A
Single Pulse Avalanche Energy ³	EAS	61	mJ
Avalanche Current	I_{AS}	35	A
Total Power Dissipation ⁴	$P_D@T_A=25^{\circ}C$	1.5	W
Storage Temperature Range	T_{STG}	-55 to 150	$^{\circ}C$
Operating Junction Temperature Range	T_J	-55 to 150	$^{\circ}C$

Thermal Characteristics

Parameter	Symbol	Typ	Max	Unit
Thermal Resistance Junction-Ambient ¹	$R_{\theta JA}$	---	85	$^{\circ}C/W$
Thermal Resistance Junction-Case ¹	$R_{\theta JC}$	---	36	$^{\circ}C/W$

Electrical Characteristics (T_J=25°C, unless otherwise noted)

Parameter	Symbol	Conditions	Min	Typ	Max	Unit
Drain-Source Breakdown Voltage	BV _{DSS}	V _{GS} =0V, I _D =250uA	30	---	---	V
BV _{DSS} Temperature Coefficient	ΔBV _{DSS} /ΔT _J	Reference to 25°C, I _D =1mA	---	0.027	---	V/°C
Static Drain-Source On-Resistance ²	R _{DS(ON)}	V _{GS} =10V, I _D =10A	---	7.5	10	mΩ
		V _{GS} =4.5V, I _D =8A	---	11	14	mΩ
Gate Threshold Voltage	V _{GS(th)}	V _{GS} =V _{DS} , I _D =250uA	1.2	---	2.5	V
V _{GS(th)} Temperature Coefficient	ΔV _{GS(th)}		---	-5.8	---	mV/°C
Drain-Source Leakage Current	I _{DSS}	V _{DS} =24V, V _{GS} =0V, T _J =25°C	---	---	1	uA
		V _{DS} =24V, V _{GS} =0V, T _J =55°C	---	---	5	
Gate-Source Leakage Current	I _{GSS}	V _{GS} =±20V, V _{DS} =0V	---	---	±100	nA
Forward Transconductance	g _{fs}	V _{DS} =5V, I _D =10A	---	5.8	---	S
Gate Resistance	R _g	V _{DS} =0V, V _{GS} =0V, f=1MHz	---	2.2	3.8	Ω
Total Gate Charge (4.5V)	Q _g	V _{DS} =15V, V _{GS} =4.5V, I _D =10A	---	12.6	---	nC
Gate-Source Charge	Q _{gs}		---	4.2	---	
Gate-Drain Charge	Q _{gd}		---	5.1	---	
Turn-On Delay Time	T _{d(on)}	V _{DD} =15V, V _{GS} =10V, R _G =3.3Ω, I _D =10A	---	6.2	---	ns
Rise Time	T _r		---	59	---	
Turn-Off Delay Time	T _{d(off)}		---	27.6	---	
Fall Time	T _f		---	8.4	---	
Input Capacitance	C _{iss}	V _{DS} =15V, V _{GS} =0V, f=1MHz	---	1317	---	pF
Output Capacitance	C _{oss}		---	163	---	
Reverse Transfer Capacitance	C _{rss}		---	131	---	

Drain-Source Diode Characteristics

Parameter	Symbol	Conditions	Min	Typ	Max	Unit
Continuous Source Current ^{1,5}	I _S	V _G =V _D =0V, Force Current	---	---	14	A
Pulsed Source Current ^{2,5}	I _{SM}		---	---	65	A
Diode Forward Voltage ²	V _{SD}	V _{GS} =0V, I _S =1A, T _J =25°C	---	---	1.2	V
Reverse Recovery Time	t _{rr}	I _F =10A, di/dt=100A/μs, T _J =25°C	---	12.5	---	nS
Reverse Recovery Charge	Q _{rr}		---	5	---	nC

Note:

- The data tested by surface mounted on a 1 inch² FR-4 board with 2OZ copper.
- The data tested by pulsed, pulse width ≤ 300us, duty cycle ≤ 2%
- The EAS data shows Max. rating. The test condition is V_{DD}=25V, V_{GS}=10V, L=0.1mH, I_{AS}=35A
- The power dissipation is limited by 150°C junction temperature
- The data is theoretically the same as I_D and I_{DM}, in real applications, should be limited by total power dissipation.

Typical Characteristics

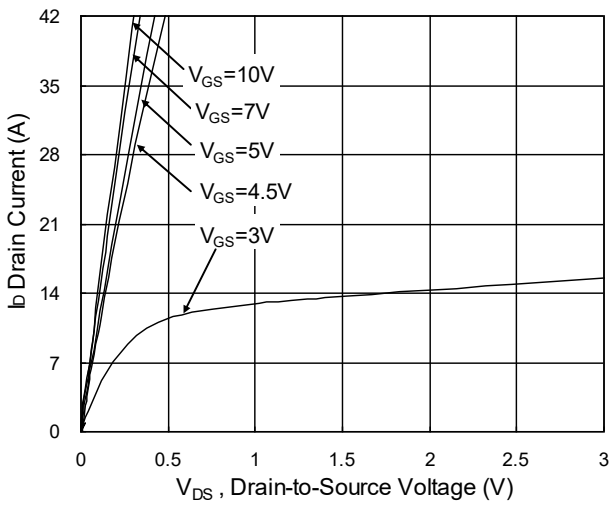

Fig.1 Typical Output Characteristics

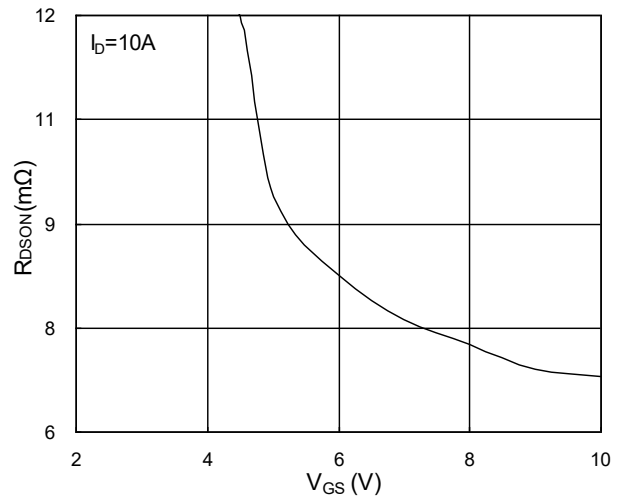

Fig.2 On-Resistance vs. Gate-Source

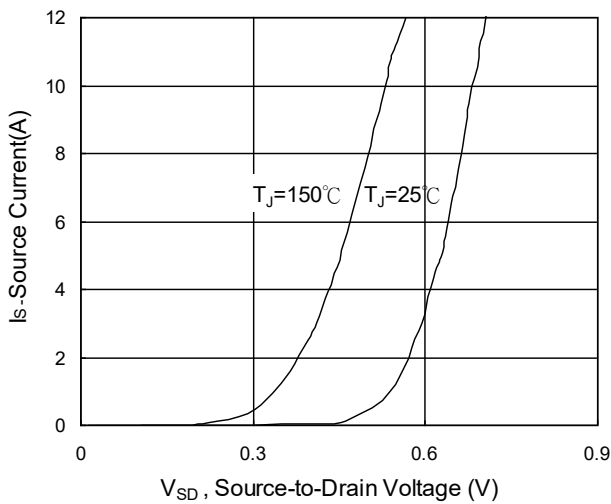

Fig.3 Forward Characteristics of reverse

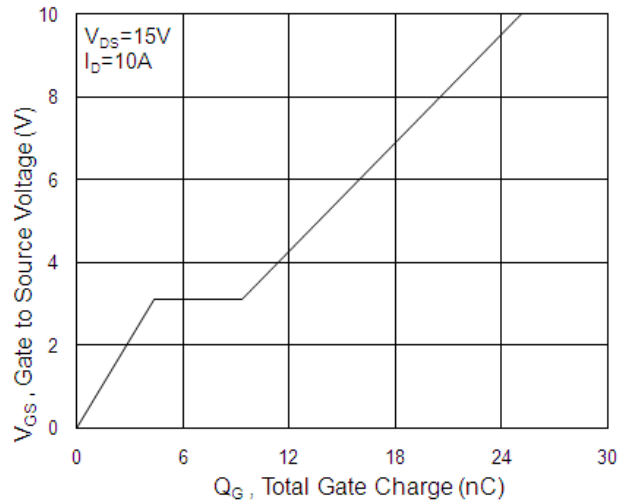

Fig.4 Gate-Charge Characteristics

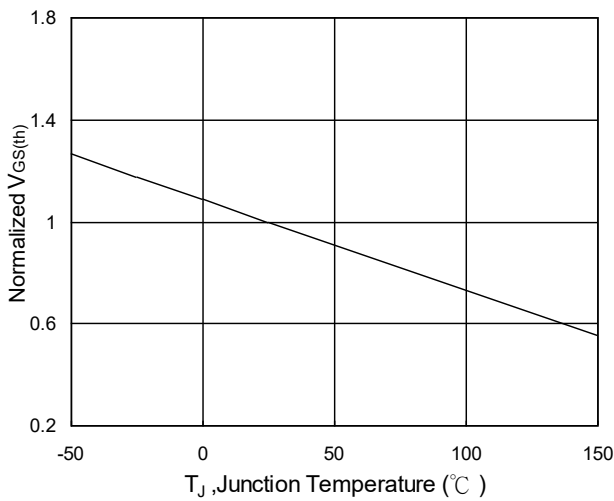

Fig.5 Normalized $V_{GS(th)}$ vs. T_J

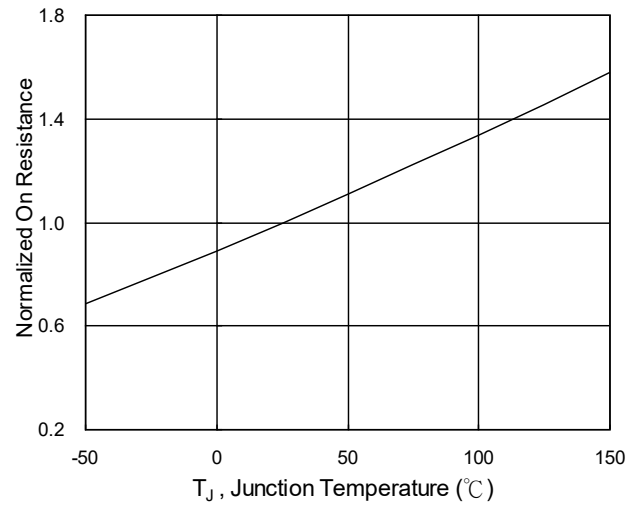

Fig.6 Normalized $R_{DS(on)}$ vs. T_J

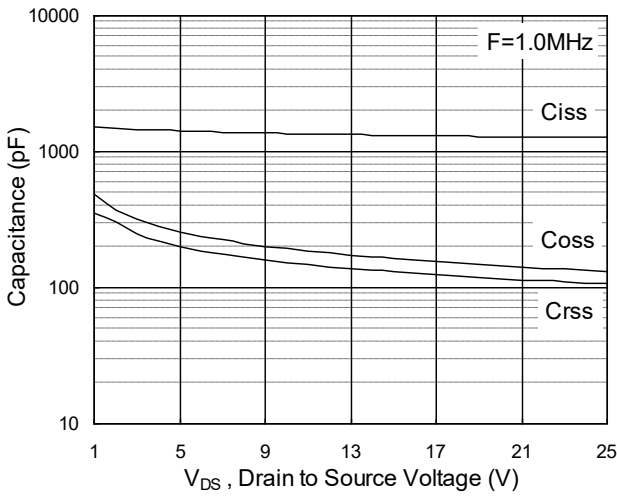

Fig.7 Capacitance

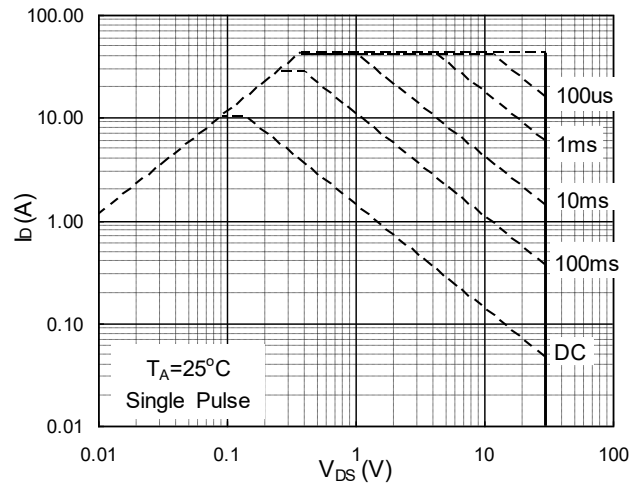

Fig.8 Safe Operating Area

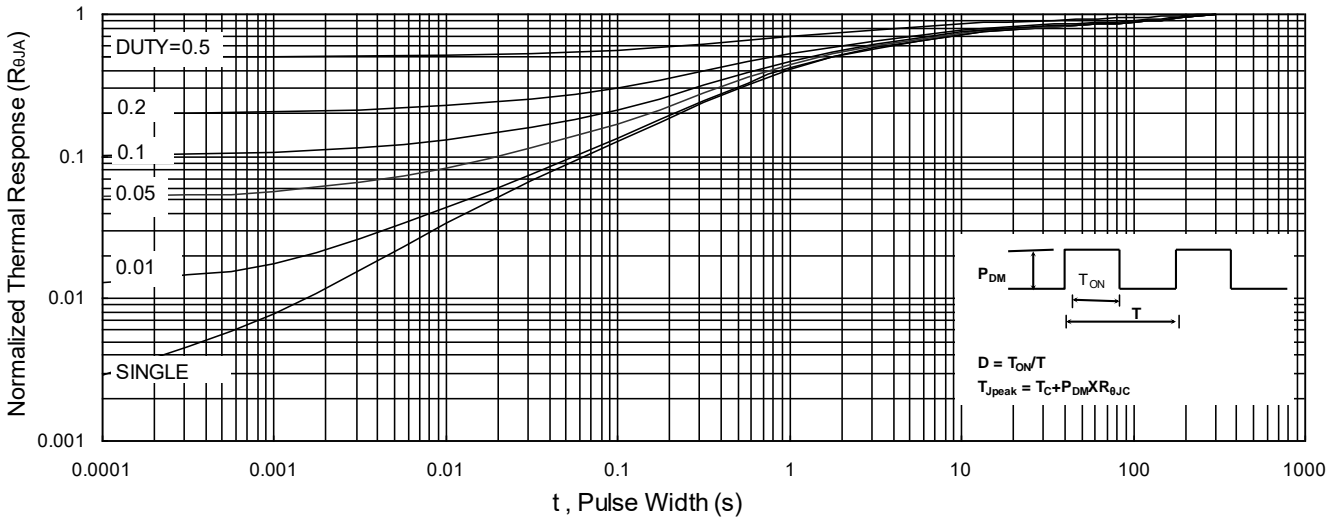

Fig.9 Normalized Maximum Transient Thermal Impedance

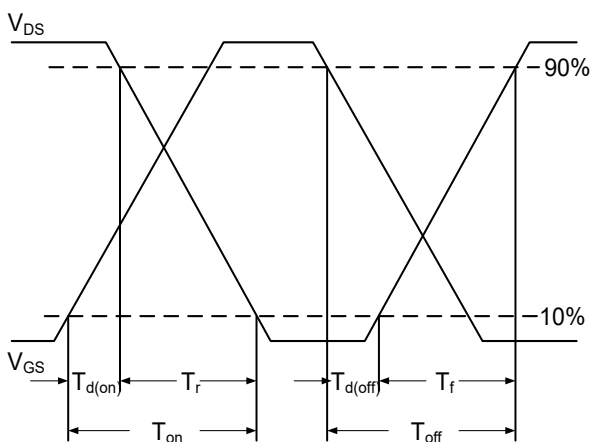

Fig.10 Switching Time Waveform

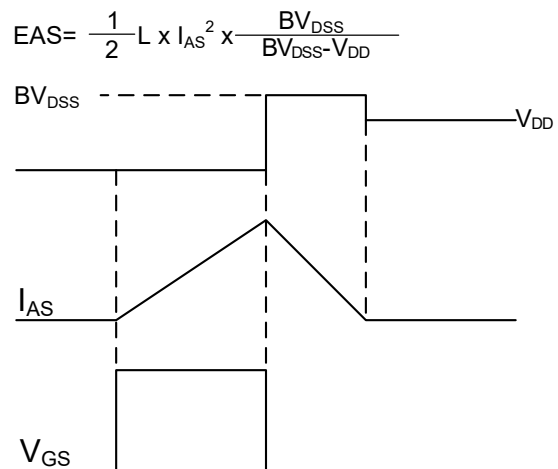
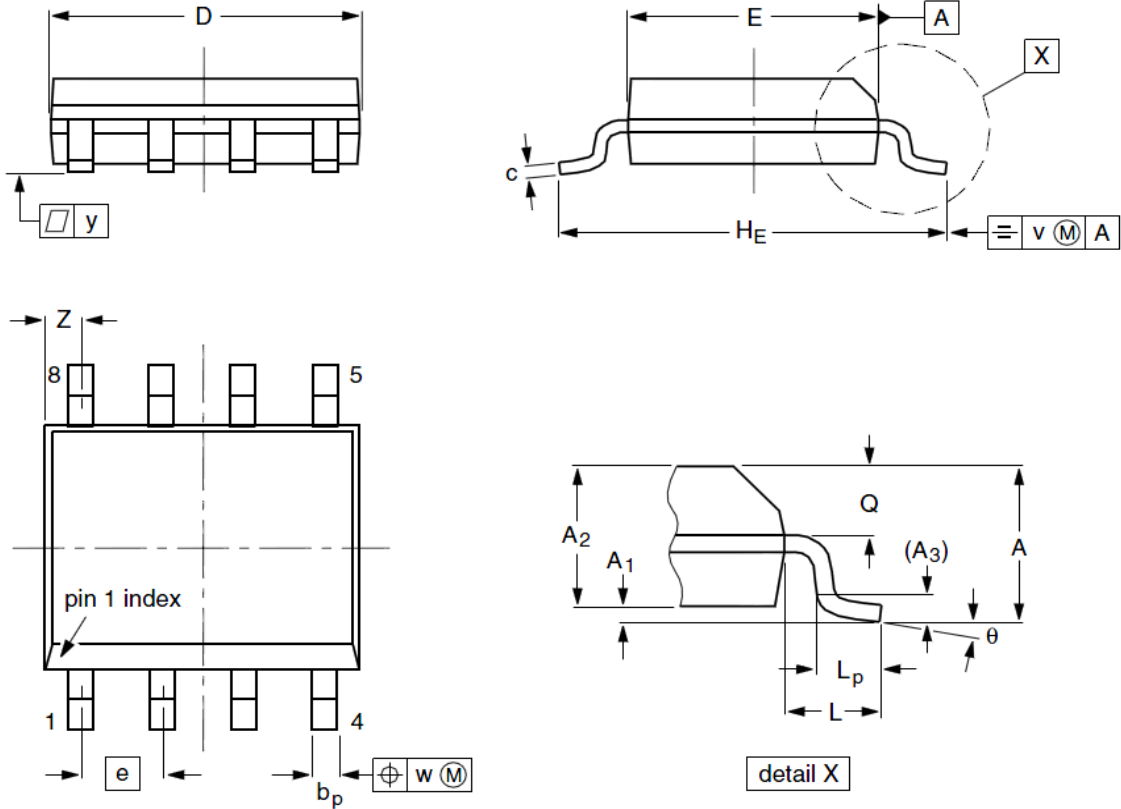

Fig.11 Unclamped Inductive Switching Waveform

SOP-8 Package Outline Dimensions



Symbol	Dimensions (unit:mm)			Symbol	Dimensions (unit:mm)		
	Min	Typ	Max		Min	Typ	Max
A	1.35	1.55	1.75	A₁	0.10	0.18	0.25
A₂	1.25	1.45	1.65	A₃	--	0.25	--
b_p	0.36	0.42	0.51	c	0.19	0.22	0.25
D	4.70	4.92	5.10	E	3.80	3.90	4.00
e	--	1.27	--	H_E	5.80	6.00	6.20
L	--	1.05	--	L_p	0.40	0.68	1.00
Q	0.60	0.65	0.73	v	--	0.25	--
w	--	0.25	--	y	--	0.10	--
Z	0.30	0.50	0.70	θ	0°		8°