

Features

- Advanced high cell density Trench technology
- Super Low Gate Charge
- Excellent CdV/dt effect decline
- 100% EAS Guaranteed
- Green Device Available

Applications

- High Frequency Point-of-Load, Synchronous Buck Converter for MB/NB/UMPC/VGA
- Networking DC-DC Power System
- Load Switch

Product Summary



V_{DS}	-60	V
I_D	-4.1	A
$R_{DS(ON)}$ (at $V_{GS}=-10V$)	90	m Ω
$R_{DS(ON)}$ (at $V_{GS}=-4.5V$)	115	m Ω

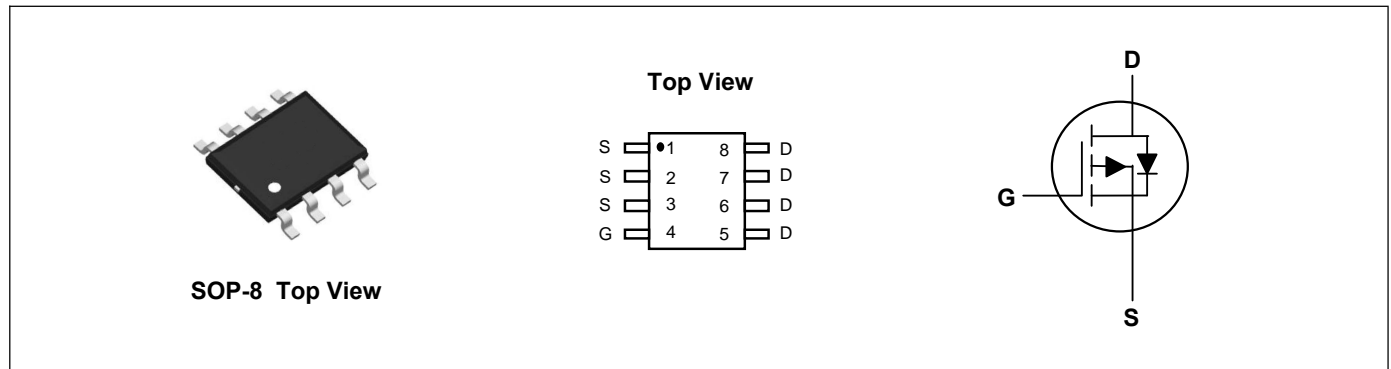

Absolute Maximum Ratings ($T_A=25^\circ\text{C}$, unless otherwise noted)

Parameter	Symbol	Rating	Units
Drain-Source Voltage	V_{DS}	-60	V
Gate-Source Voltage	V_{GS}	± 20	V
Continuous Drain Current, $V_{GS} @ -10V^1$	$I_D @ T_A=25^\circ\text{C}$	-4.1	A
Continuous Drain Current, $V_{GS} @ -10V^1$	$I_D @ T_A=70^\circ\text{C}$	-3.2	A
Pulsed Drain Current ²	I_{DM}	-8.2	A
Single Pulse Avalanche Energy ³	EAS	29.7	mJ
Avalanche Current	I_{AS}	-24.4	A
Total Power Dissipation ⁴	$P_D @ T_A=25^\circ\text{C}$	3.1	W
Storage Temperature Range	T_{STG}	-55 to 150	$^\circ\text{C}$
Operating Junction Temperature Range	T_J	-55 to 150	$^\circ\text{C}$

Thermal Characteristics

Parameter	Symbol	Typ	Max	Unit
Thermal Resistance Junction-Ambient ¹	$R_{\theta JA}$	---	85	$^\circ\text{C/W}$
Thermal Resistance Junction-Case ¹	$R_{\theta JC}$	---	36	$^\circ\text{C/W}$

Electrical Characteristics (T_J=25°C, unless otherwise noted)

Parameter	Symbol	Conditions	Min	Typ	Max	Unit
Drain-Source Breakdown Voltage	BV _{DSS}	V _{GS} =0V, I _D =-250uA	-60	---	---	V
BV _{DSS} Temperature Coefficient	ΔBV _{DSS} /ΔT _J	Reference to 25°C, I _D =-1mA	---	-0.03	---	V/°C
Static Drain-Source On-Resistance ²	R _{DS(ON)}	V _{GS} =-10V, I _D =-3A	---	70	90	mΩ
		V _{GS} =-4.5V, I _D =-2A	---	90	115	mΩ
Gate Threshold Voltage	V _{GS(th)}	V _{GS} =V _{DS} , I _D =-250uA	-1.0	---	-2.5	V
V _{GS(th)} Temperature Coefficient	ΔV _{GS(th)}		---	4.56	---	mV/°C
Drain-Source Leakage Current	I _{DSS}	V _{DS} =-48V, V _{GS} =0V, T _J =25°C	---	---	1	uA
		V _{DS} =-48V, V _{GS} =0V, T _J =55°C	---	---	5	uA
Gate-Source Leakage Current	I _{GSS}	V _{GS} =±20V, V _{DS} =0V	---	---	±100	nA
Forward Transconductance	g _{fs}	V _{DS} =-5V, I _D =-3A	---	8.7	---	S
Gate Resistance	R _g	V _{DS} =0V, V _{GS} =0V, f=1MHz	---	15	---	Ω
Total Gate Charge (-4.5V)	Q _g	V _{DS} =-48V, V _{GS} =-4.5V, I _D =-3A	---	11.8	---	nC
Gate-Source Charge	Q _{gs}		---	1.9	---	
Gate-Drain Charge	Q _{gd}		---	6.5	---	
Turn-On Delay Time	T _{d(on)}	V _{DD} =-15V, V _{GS} =-10V, R _G =3.3Ω, I _D =-1A	---	8.8	---	ns
Rise Time	T _r		---	19.6	---	
Turn-Off Delay Time	T _{d(off)}		---	47.8	---	
Fall Time	T _f		---	6.9	---	
Input Capacitance	C _{iss}	V _{DS} =-15V, V _{GS} =0V, f=1MHz	---	1080	---	pF
Output Capacitance	C _{oss}		---	73	---	
Reverse Transfer Capacitance	C _{rss}		---	50	---	

Drain-Source Diode Characteristics

Parameter	Symbol	Conditions	Min	Typ	Max	Unit
Continuous Source Current ^{1,5}	I _S	V _G =V _D =0V, Force Current	---	---	-4.1	A
Pulsed Source Current ^{2,5}	I _{SM}		---	---	-8.2	A
Diode Forward Voltage ²	V _{SD}	V _{GS} =0V, I _S =-1A, T _J =25°C	---	---	-1.2	V

Note:

- 1.The data tested by surface mounted on a 1 inch²FR-4 board with 2OZ copper.
- 2.The data tested by pulsed, pulse width ≤ 300us, duty cycle ≤ 2%
- 3.The EAS data shows Max. rating. The test condition is V_{DD}=-25V, V_{GS}=-10V, L=0.1mH, I_{AS}=-24.4A
- 4.The power dissipation is limited by 150°C junction temperature
- 5.The data is theoretically the same as I_D and I_{DM}, in real applications, should be limited by total power dissipation.

Typical Characteristics

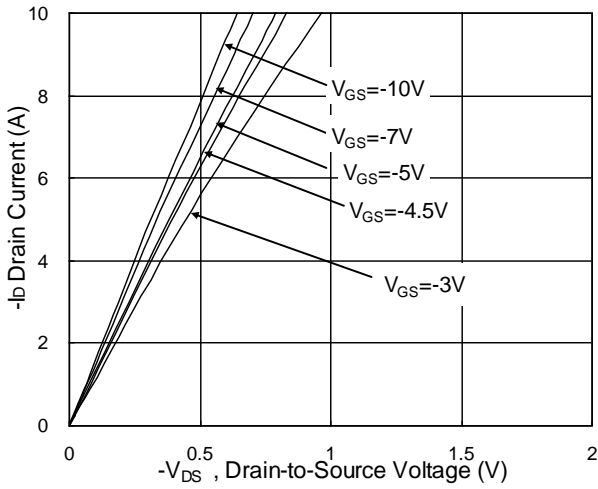

Fig.1 Typical Output Characteristics

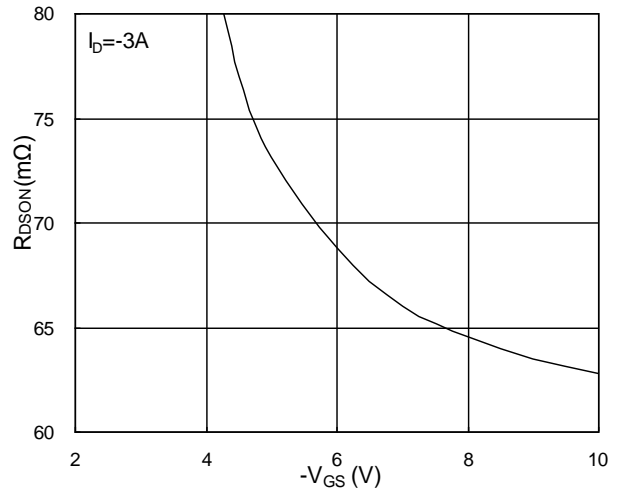

Fig.2 On-Resistance v.s Gate-Source

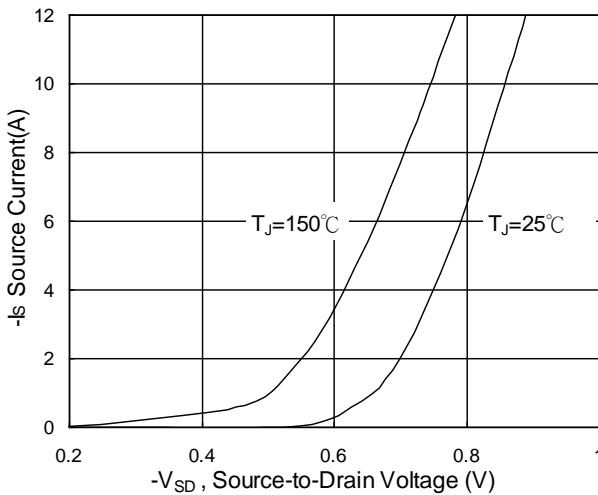

Fig.3 Forward Characteristics of Reverse

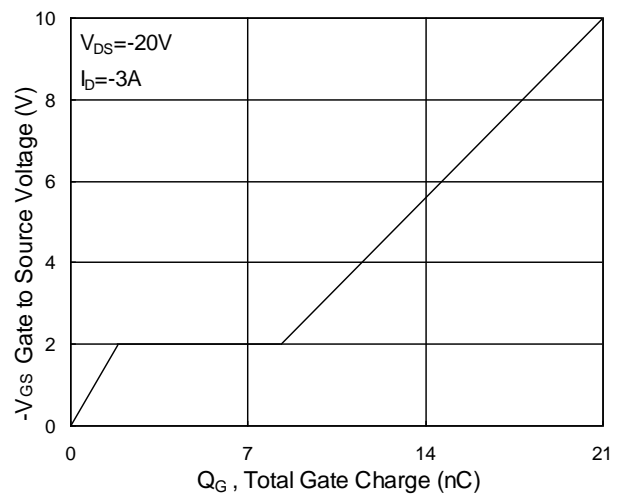

Fig.4 Gate-Charge Characteristics

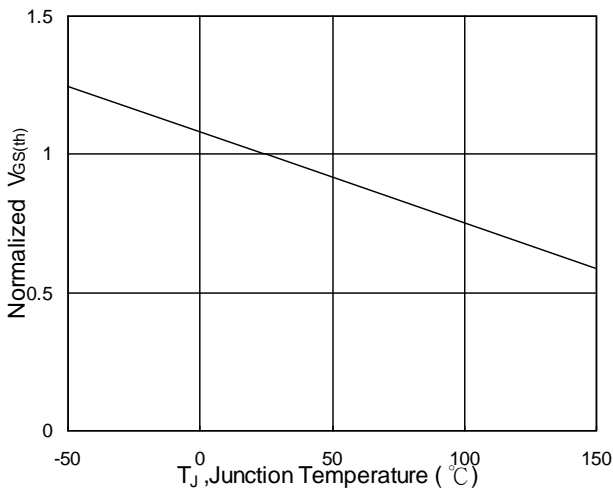

Fig.5 Normalized $V_{GS(th)}$ vs. T_J

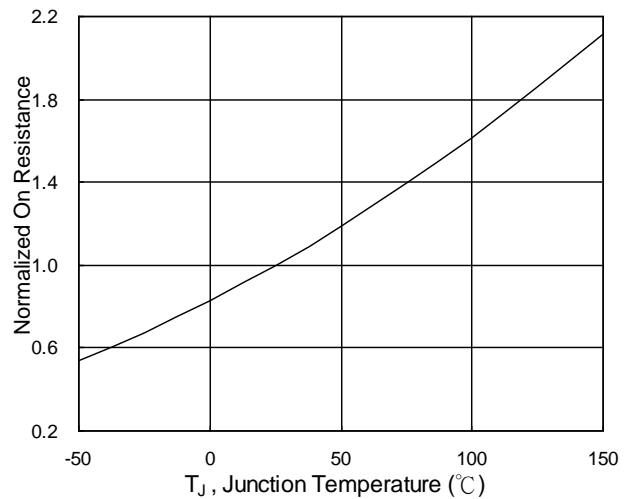

Fig.6 Normalized $R_{DS(on)}$ vs. T_J

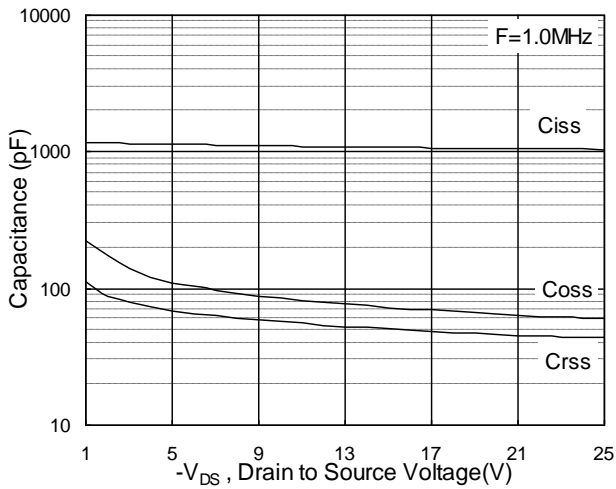

Fig.7 Capacitance

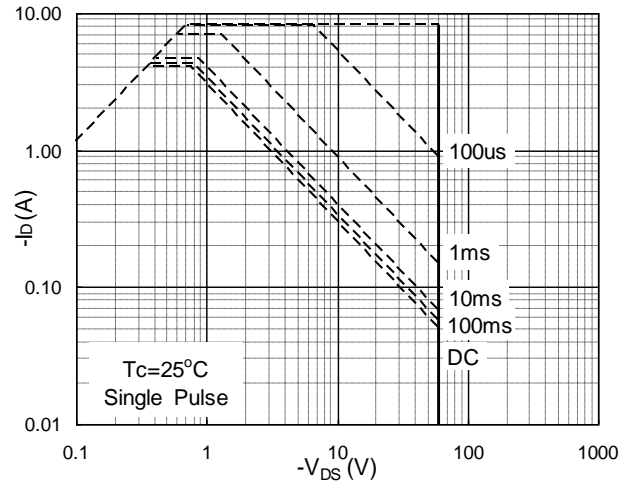

Fig.8 Safe Operating Area

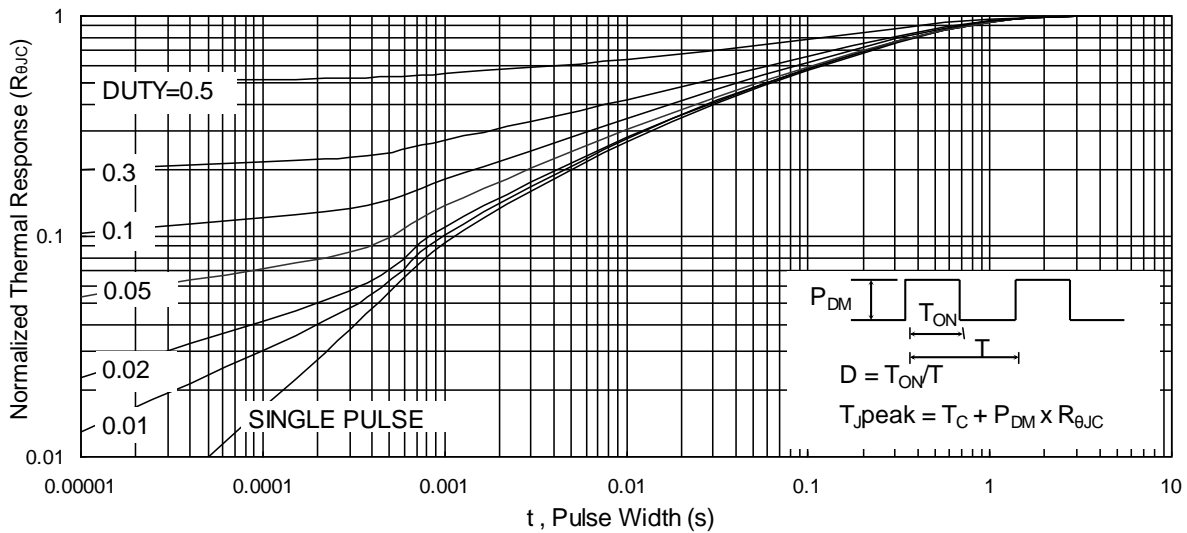

Fig.9 Normalized Maximum Transient Thermal Impedance

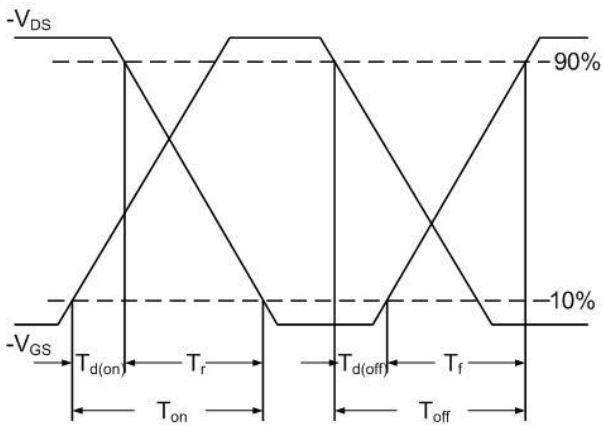

Fig.10 Switching Time Waveform

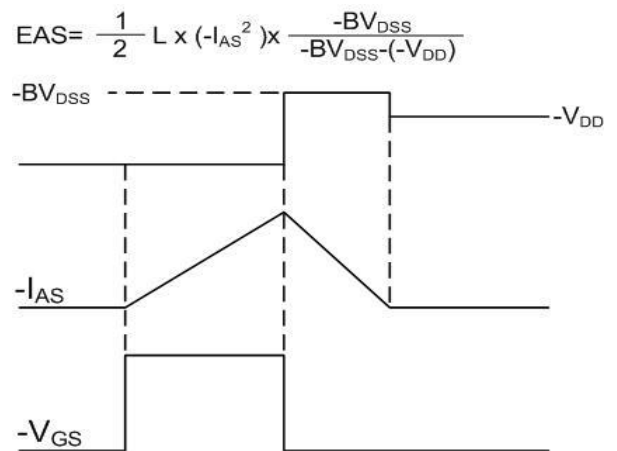

Fig.11 Unclamped Inductive Waveform

SOP-8 Package Outline Dimensions



Symbol	Dimensions (unit:mm)			Symbol	Dimensions (unit:mm)		
	Min	Typ	Max		Min	Typ	Max
A	1.35	1.55	1.75	A₁	0.10	0.18	0.25
A₂	1.25	1.45	1.65	A₃	--	0.25	--
b_p	0.36	0.42	0.51	c	0.19	0.22	0.25
D	4.70	4.92	5.10	E	3.80	3.90	4.00
e	--	1.27	--	H_E	5.80	6.00	6.20
L	--	1.05	--	L_p	0.40	0.68	1.00
Q	0.60	0.65	0.73	v	--	0.25	--
w	--	0.25	--	y	--	0.10	--
Z	0.30	0.50	0.70	θ	0°		8°