

## Features

- Advanced high cell density Trench technology
- Super Low Gate Charge
- Excellent CdV/dt effect decline
- 100% EAS Guaranteed
- Green Device Available

## Applications

- High Frequency Point-of-Load, Synchronous Buck Converter for MB/NB/UMPC/VGA
- Networking DC-DC Power System
- Load Switch

## Product Summary



$V_{DS}$	60	V
$I_D$	4.5	A
$R_{DS(ON)}$ (at $V_{GS}=10V$ )	40	m $\Omega$
$R_{DS(ON)}$ (at $V_{GS}=4.5V$ )	50	m $\Omega$

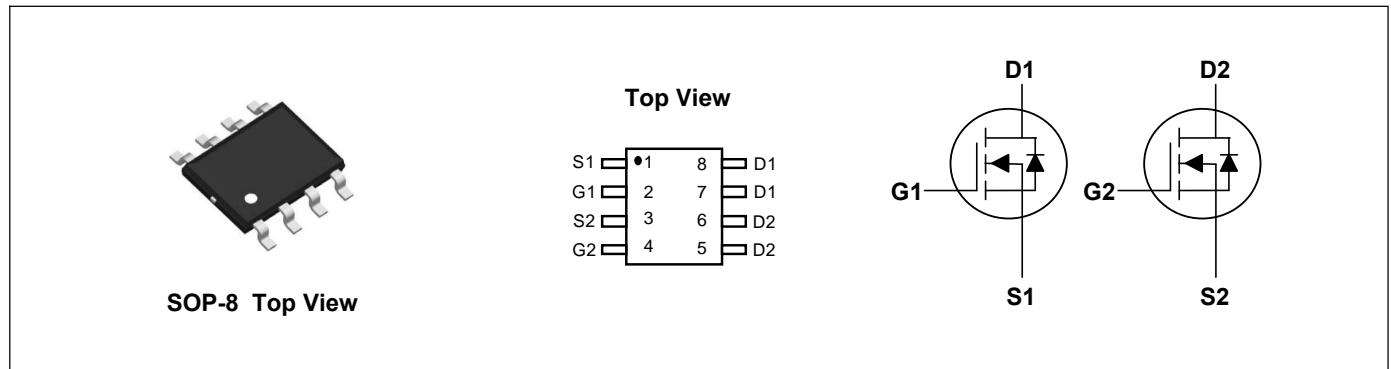

## Absolute Maximum Ratings ( $T_A=25^\circ C$ , unless otherwise noted)

Parameter	Symbol	Rating	Units
Drain-Source Voltage	$V_{DS}$	60	V
Gate-Source Voltage	$V_{GS}$	$\pm 20$	V
Continuous Drain Current, $V_{GS} @ 10V^1$	$I_D @ T_A=25^\circ C$	4.5	A
Continuous Drain Current, $V_{GS} @ 10V^1$	$I_D @ T_A=70^\circ C$	3.5	A
Pulsed Drain Current <sup>2</sup>	$I_{DM}$	18	A
Single Pulse Avalanche Energy <sup>3</sup>	EAS	22	mJ
Avalanche Current	$I_{AS}$	21	A
Total Power Dissipation <sup>4</sup>	$P_D @ T_A=25^\circ C$	1.5	W
Storage Temperature Range	$T_{STG}$	-55 to 150	$^\circ C$
Operating Junction Temperature Range	$T_J$	-55 to 150	$^\circ C$

## Thermal Characteristics

Parameter	Symbol	Typ	Max	Unit
Thermal Resistance Junction-Ambient <sup>1</sup>	$R_{\theta JA}$	---	85	$^\circ C/W$
Thermal Resistance Junction-Case <sup>1</sup>	$R_{\theta JC}$	---	25	$^\circ C/W$

**Electrical Characteristics (T<sub>J</sub>=25°C, unless otherwise noted)**

Parameter	Symbol	Conditions	Min	Typ	Max	Unit
Drain-Source Breakdown Voltage	BV <sub>DSS</sub>	V <sub>GS</sub> =0V, I <sub>D</sub> =250uA	60	---	---	V
BV <sub>DSS</sub> Temperature Coefficient	ΔBV <sub>DSS</sub> /ΔT <sub>J</sub>	Reference to 25°C, I <sub>D</sub> =1mA	---	0.044	---	V/°C
Static Drain-Source On-Resistance <sup>2</sup>	R <sub>DS(ON)</sub>	V <sub>GS</sub> =10V, I <sub>D</sub> =4A	---	---	40	mΩ
		V <sub>GS</sub> =4.5V, I <sub>D</sub> =3A	---	---	50	mΩ
Gate Threshold Voltage	V <sub>GS(th)</sub>	V <sub>GS</sub> =V <sub>DS</sub> , I <sub>D</sub> =250uA	1.0	---	2.5	V
V <sub>GS(th)</sub> Temperature Coefficient	ΔV <sub>GS(th)</sub>		---	-4.8	---	mV/°C
Drain-Source Leakage Current	I <sub>DSS</sub>	V <sub>DS</sub> =48V, V <sub>GS</sub> =0V, T <sub>J</sub> =25°C	---	---	1	uA
		V <sub>DS</sub> =48V, V <sub>GS</sub> =0V, T <sub>J</sub> =55°C	---	---	5	
Gate-Source Leakage Current	I <sub>GSS</sub>	V <sub>GS</sub> =±20V, V <sub>DS</sub> =0V	---	---	±100	nA
Forward Transconductance	g <sub>fs</sub>	V <sub>DS</sub> =5V, I <sub>D</sub> =4A	---	28.3	---	S
Gate Resistance	R <sub>g</sub>	V <sub>DS</sub> =0V, V <sub>GS</sub> =0V, f=1MHz	---	2.5	---	Ω
Total Gate Charge	Q <sub>g</sub>	V <sub>DS</sub> =48V, V <sub>GS</sub> =10V, I <sub>D</sub> =4A	---	19	---	nC
Gate-Source Charge	Q <sub>gs</sub>		---	2.6	---	
Gate-Drain Charge	Q <sub>gd</sub>		---	4.1	---	
Turn-On Delay Time	T <sub>d(on)</sub>	V <sub>DD</sub> =30V, V <sub>GS</sub> =10V, R <sub>G</sub> =3.3Ω, I <sub>D</sub> =4A	---	3	---	ns
Rise Time	T <sub>r</sub>		---	34	---	
Turn-Off Delay Time	T <sub>d(off)</sub>		---	23	---	
Fall Time	T <sub>f</sub>		---	6	---	
Input Capacitance	C <sub>iss</sub>	V <sub>DS</sub> =15V, V <sub>GS</sub> =0V, f=1MHz	---	1027	---	pF
Output Capacitance	C <sub>oss</sub>		---	65	---	
Reverse Transfer Capacitance	C <sub>rss</sub>		---	46	---	

**Drain-Source Diode Characteristics**

Parameter	Symbol	Conditions	Min	Typ	Max	Unit
Continuous Source Current <sup>1,5</sup>	I <sub>S</sub>	V <sub>G</sub> =V <sub>D</sub> =0V, Force Current	---	---	4.5	A
Pulsed Source Current <sup>2,5</sup>	I <sub>SM</sub>		---	---	18	A
Diode Forward Voltage <sup>2</sup>	V <sub>SD</sub>	V <sub>GS</sub> =0V, I <sub>S</sub> =1A, T <sub>J</sub> =25°C	---	---	1.2	V
Reverse Recovery Time	t <sub>rr</sub>	I <sub>F</sub> =-4A, di/dt=100A/μs, T <sub>J</sub> =25°C	---	12.1	---	nS
Reverse Recovery Charge	Q <sub>rr</sub>		---	6.7	---	nC

**Note:**

1. The data tested by surface mounted on a 1 inch<sup>2</sup> FR-4 board with 2OZ copper.
2. The data tested by pulsed, pulse width ≤ 300us, duty cycle ≤ 2%
3. The EAS data shows Max. rating. The test condition is V<sub>DD</sub>=25V, V<sub>GS</sub>=10V, L=0.1mH
4. The power dissipation is limited by 150°C junction temperature
5. The data is theoretically the same as I<sub>D</sub> and I<sub>DM</sub>, in real applications, should be limited by total power dissipation.

**Typical Characteristics**

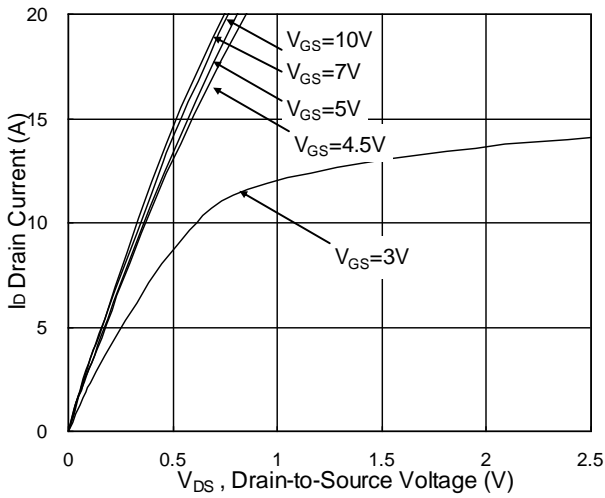

**Fig.1 Typical Output Characteristics**

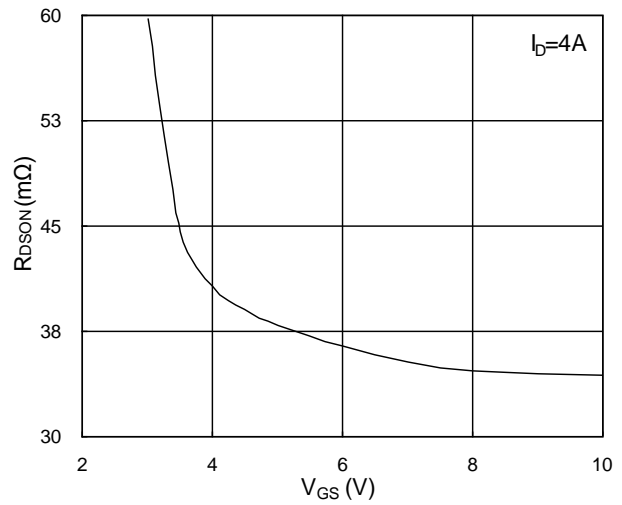

**Fig.2 On-Resistance vs. Gate-Source**

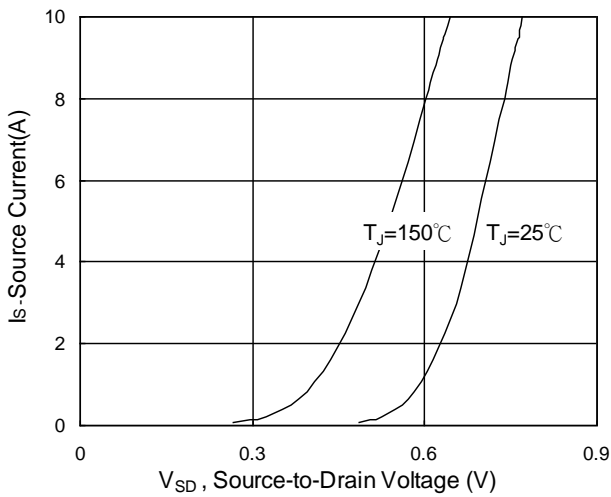

**Fig.3 Forward Characteristics Of Reverse**

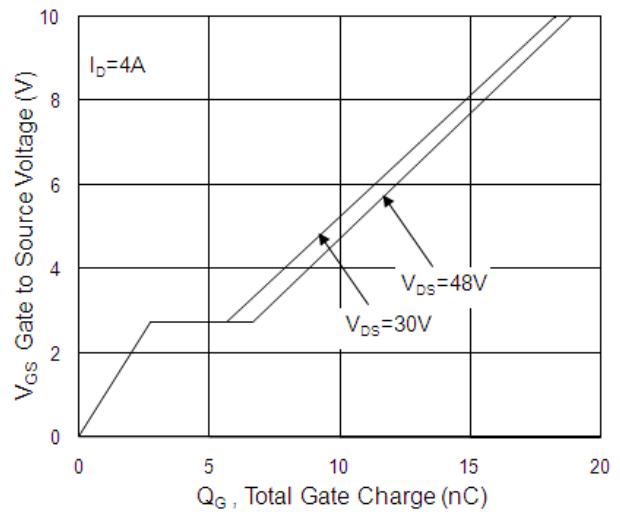

**Fig.4 Gate-Charge Characteristics**

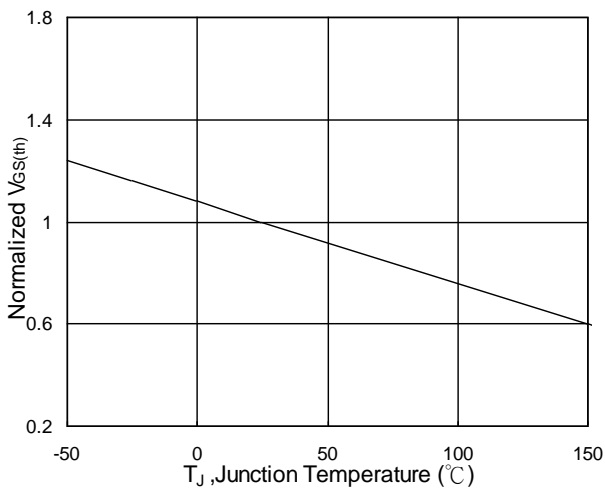

**Fig.5 Normalized  $V_{GS(th)}$  vs.  $T_J$**

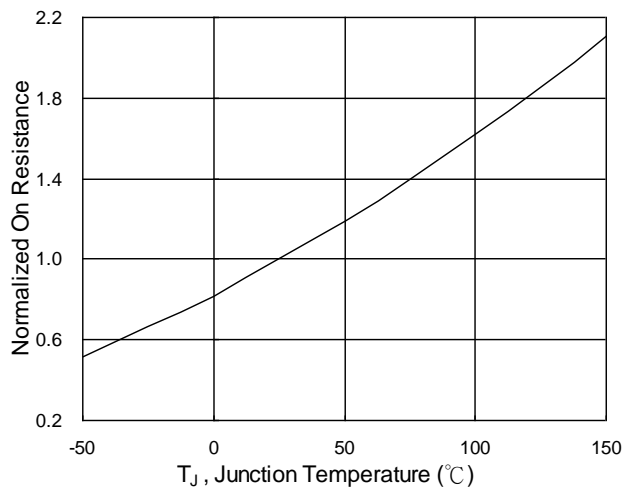

**Fig.6 Normalized  $R_{DS(on)}$  vs.  $T_J$**

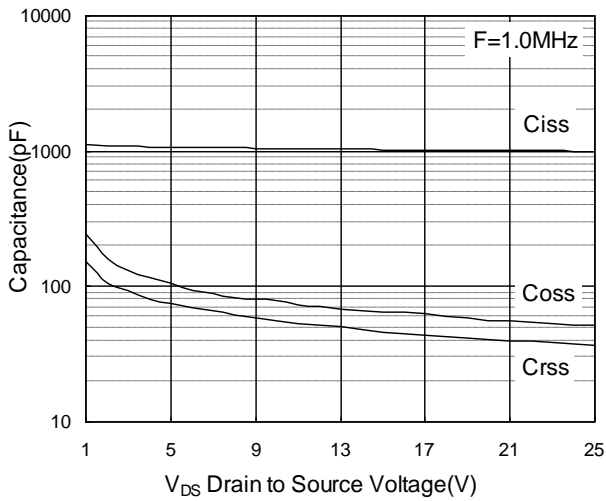

**Fig.7 Capacitance**

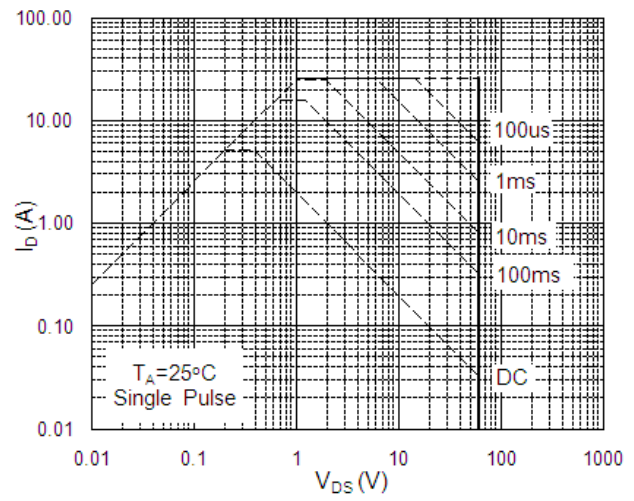

**Fig.8 Safe Operating Area**

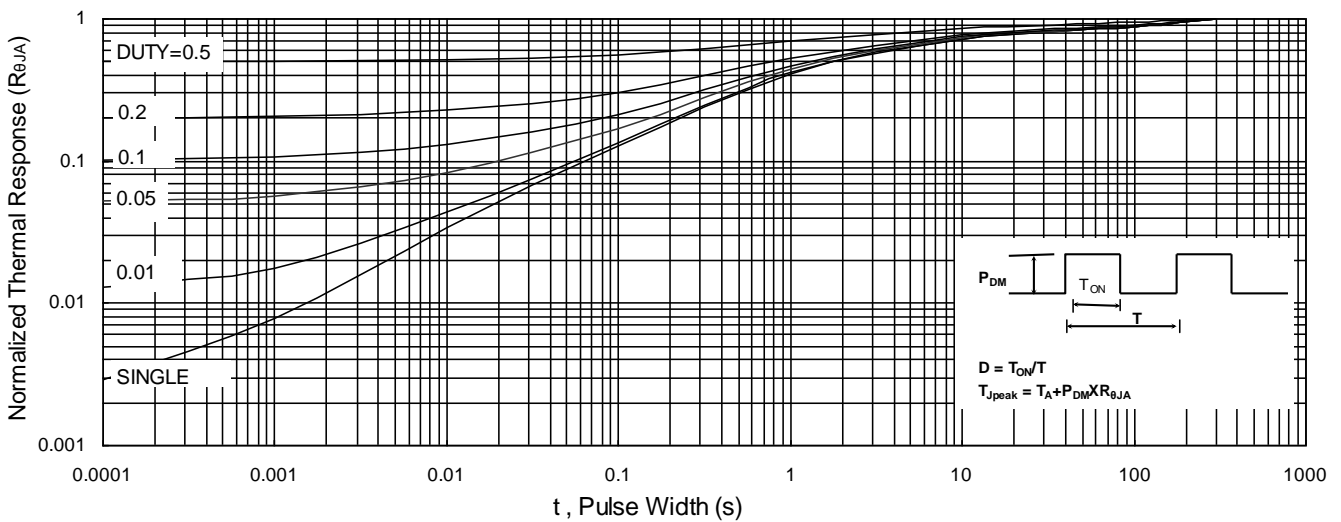

**Fig.9 Normalized Maximum Transient Thermal Impedance**

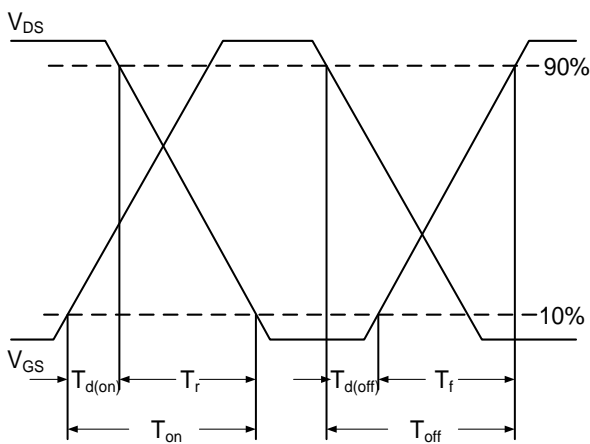

**Fig.10 Switching Time Waveform**

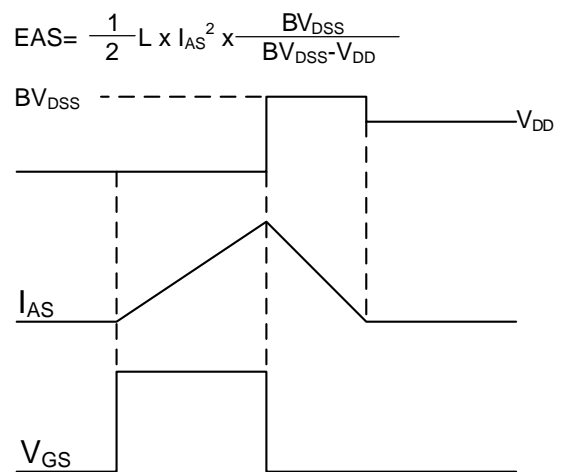

**Fig.11 Unclamped Inductive Switching Waveform**

**SOP-8 Package Outline Dimensions**



Symbol	Dimensions (unit:mm)			Symbol	Dimensions (unit:mm)		
	Min	Typ	Max		Min	Typ	Max
<b>A</b>	1.35	1.55	1.75	<b>A<sub>1</sub></b>	0.10	0.18	0.25
<b>A<sub>2</sub></b>	1.25	1.45	1.65	<b>A<sub>3</sub></b>	--	0.25	--
<b>b<sub>p</sub></b>	0.36	0.42	0.51	<b>c</b>	0.19	0.22	0.25
<b>D</b>	4.70	4.92	5.10	<b>E</b>	3.80	3.90	4.00
<b>e</b>	--	1.27	--	<b>H<sub>E</sub></b>	5.80	6.00	6.20
<b>L</b>	--	1.05	--	<b>L<sub>p</sub></b>	0.40	0.68	1.00
<b>Q</b>	0.60	0.65	0.73	<b>v</b>	--	0.25	--
<b>w</b>	--	0.25	--	<b>y</b>	--	0.10	--
<b>Z</b>	0.30	0.50	0.70	<b>θ</b>	0°		8°