

Features

- Advanced high cell density Trench technology
- Super Low Gate Charge
- Excellent CdV/dt effect decline
- 100% EAS Guaranteed
- Green Device Available

Applications

- High Frequency Point-of-Load, Synchronous Buck Converter
- Networking DC-DC Power System
- Load Switch, Motor Drive Applications

Product Summary



	N-Ch	P-Ch	
V_{DS}	40	-40	V
I_D	23	-20	A
$R_{DS(ON)}$ (at $V_{GS}=\pm 10V$)	30	45	m Ω
$R_{DS(ON)}$ (at $V_{GS}=\pm 4.5V$)	50	70	m Ω

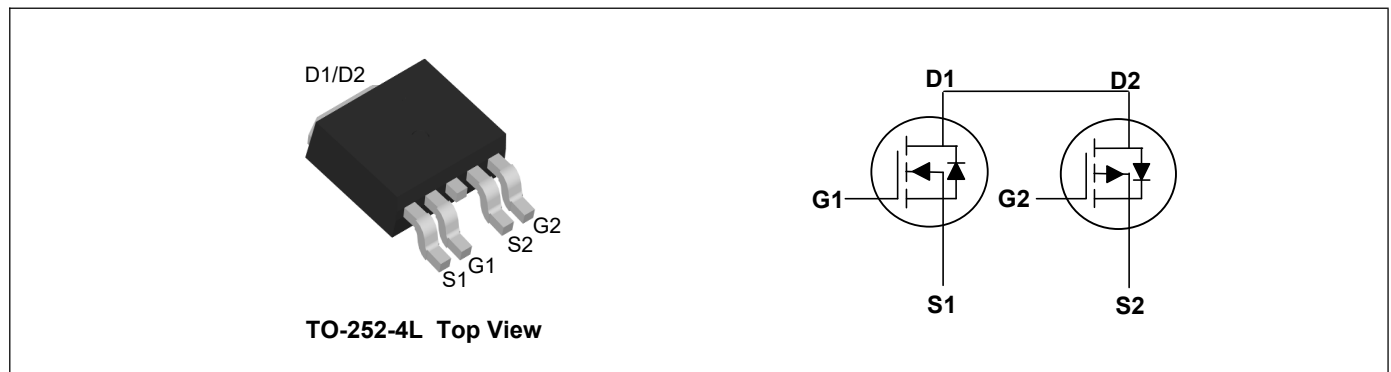

Absolute Maximum Ratings ($T_c=25^\circ\text{C}$, unless otherwise noted)

Parameter	Symbol	N-Ch	P-Ch	Units
Drain-Source Voltage	V_{DS}	40	-40	V
Gate-Source Voltage	V_{GS}	± 20	± 20	V
Continuous Drain Current, $V_{GS} @ \pm 10V^1$	$I_D @ T_c=25^\circ\text{C}$	23	-20	A
Continuous Drain Current, $V_{GS} @ \pm 10V^1$	$I_D @ T_c=100^\circ\text{C}$	18	-16	A
Pulsed Drain Current ²	I_{DM}	46	-40	A
Single Pulse Avalanche Energy ³	EAS	28	66	mJ
Avalanche Current	I_{AS}	17.8	-27.2	A
Total Power Dissipation ⁴	$P_D @ T_c=25^\circ\text{C}$	25	31.3	W
Storage Temperature Range	T_{STG}	-55 to 150		$^\circ\text{C}$
Operating Junction Temperature Range	T_J	-55 to 150		$^\circ\text{C}$

Thermal Characteristics

Parameter	Symbol	Typ	Max	Unit
Thermal Resistance Junction-Ambient ¹	$R_{\theta JA}$	---	62	$^\circ\text{C/W}$
Thermal Resistance Junction-Case ¹	$R_{\theta JC}$	---	5	$^\circ\text{C/W}$

N-Ch Electrical Characteristics (T_J=25°C, unless otherwise noted)

Parameter	Symbol	Conditions	Min	Typ	Max	Unit
Drain-Source Breakdown Voltage	BV _{DSS}	V _{GS} =0V, I _D =250uA	40	---	---	V
BV _{DSS} Temperature Coefficient	ΔBV _{DSS} /ΔT _J	Reference to 25°C, I _D =1mA	---	0.034	---	V/°C
Static Drain-Source On-Resistance ²	R _{DS(ON)}	V _{GS} =10V, I _D =12A	---	---	30	mΩ
		V _{GS} =4.5V, I _D =10A	---	---	50	mΩ
Gate Threshold Voltage	V _{GS(th)}	V _{GS} =V _{DS} , I _D =250uA	1.0	---	2.5	V
V _{GS(th)} Temperature Coefficient	ΔV _{GS(th)}		---	-4.56	---	mV/°C
Drain-Source Leakage Current	I _{DSS}	V _{DS} =32V, V _{GS} =0V, T _J =25°C	---	---	1	uA
		V _{DS} =32V, V _{GS} =0V, T _J =55°C	---	---	5	uA
Gate-Source Leakage Current	I _{GSS}	V _{GS} =±20V, V _{DS} =0V	---	---	±100	nA
Forward Transconductance	g _{fs}	V _{DS} =5V, I _D =12A	---	8	---	S
Gate Resistance	R _g	V _{DS} =0V, V _{GS} =0V, f=1MHz	---	2.6	5.2	Ω
Total Gate Charge	Q _g	V _{DS} =20V, V _{GS} =4.5V, I _D =12A	---	5.5	---	nC
Gate-Source Charge	Q _{gs}		---	1.25	---	
Gate-Drain Charge	Q _{gd}		---	2.5	---	
Turn-On Delay Time	T _{d(on)}	V _{DD} =20V, V _{GS} =10V, R _G =3.3Ω, I _D =1A	---	8.9	---	ns
Rise Time	T _r		---	2.2	---	
Turn-Off Delay Time	T _{d(off)}		---	41	---	
Fall Time	T _f		---	2.7	---	
Input Capacitance	C _{iss}	V _{DS} =15V, V _{GS} =0V, f=1MHz	---	593	---	pF
Output Capacitance	C _{oss}		---	76	---	
Reverse Transfer Capacitance	C _{rss}		---	56	---	

Drain-Source Diode Characteristics

Parameter	Symbol	Conditions	Min	Typ	Max	Unit
Continuous Source Current ^{1,5}	I _S	V _G =V _D =0V, Force Current	---	---	23	A
Pulsed Source Current ^{2,5}	I _{SM}		---	---	46	A
Diode Forward Voltage ²	V _{SD}	V _{GS} =0V, I _S =1A, T _J =25°C	---	---	1.2	V

Note:

1. The data tested by surface mounted on a 1 inch² FR-4 board with 2OZ copper.
2. The data tested by pulsed, pulse width ≤ 300us, duty cycle ≤ 2%
3. The EAS data shows Max. rating. The test condition is V_{DD}=25V, V_{GS}=10V, L=0.1mH
4. The power dissipation is limited by 150°C junction temperature
5. The data is theoretically the same as I_D and I_{DM}, in real applications, should be limited by total power dissipation.

N-Ch Typical Characteristics

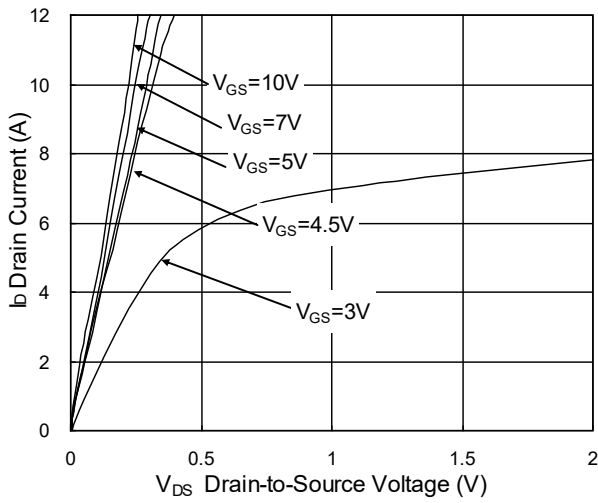

Fig.1 Typical Output Characteristics

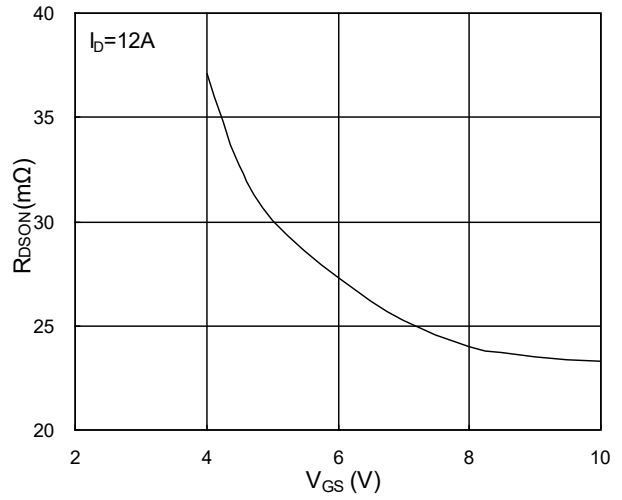

Fig.2 On-Resistance vs. G-S Voltage

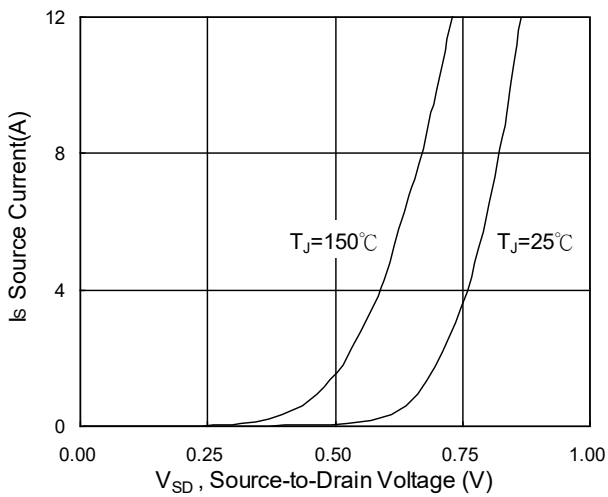

Fig.3 Forward Characteristics of Reverse

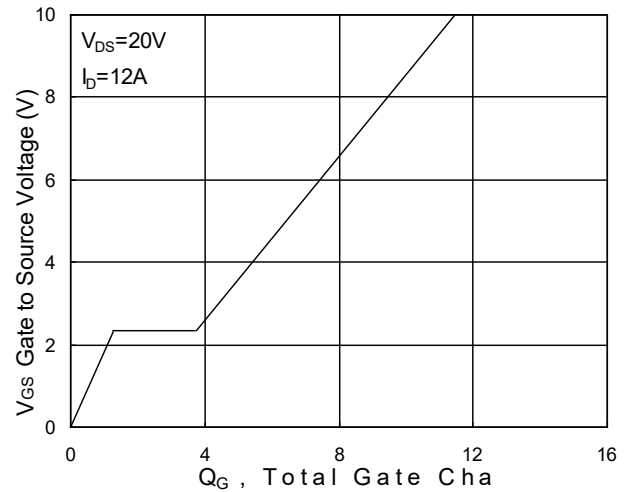

Fig.4 Gate-Charge Characteristics

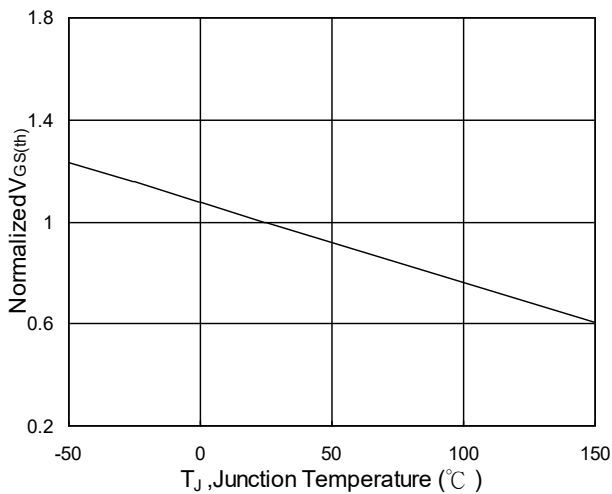

Fig.5 Normalized $V_{GS(th)}$ vs. T_J

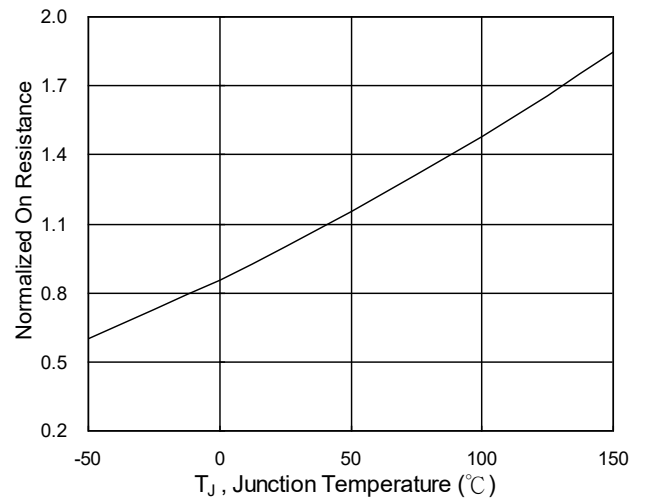

Fig.6 Normalized $R_{DS(on)}$ vs. T_J

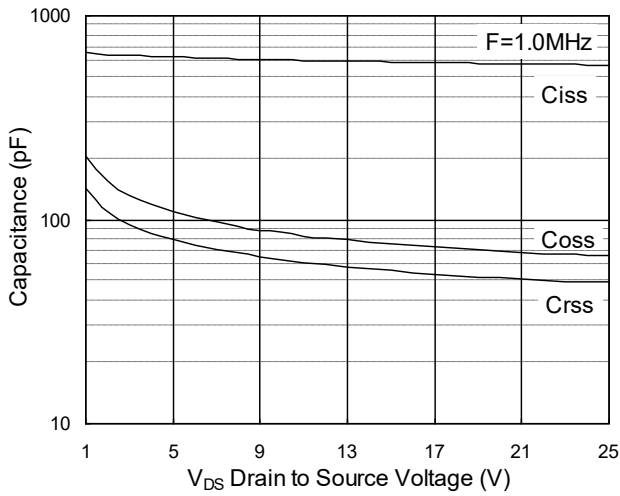

Fig.7 Capacitance

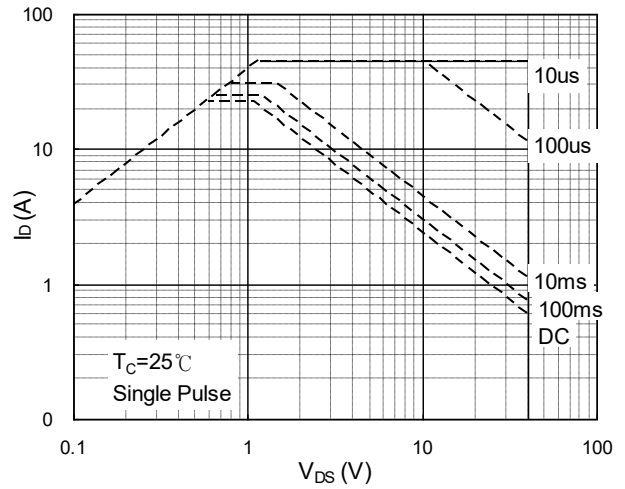

Fig.8 Safe Operating Area

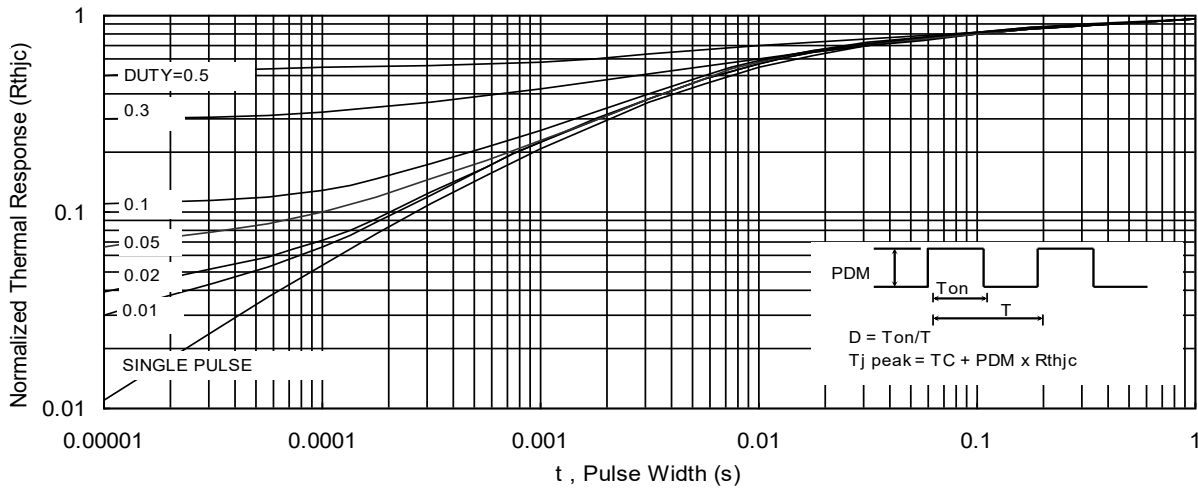

Fig.9 Normalized Maximum Transient Thermal Impedance

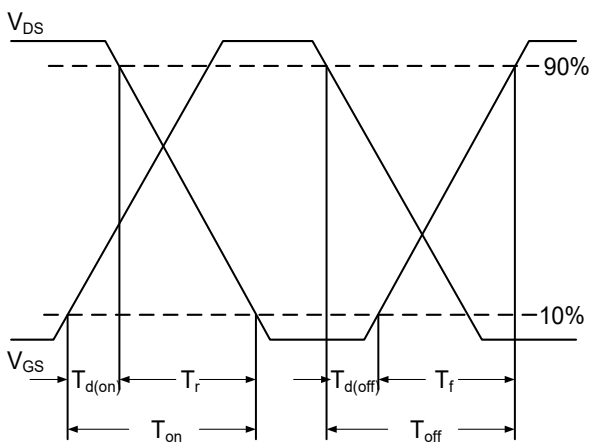

Fig.10 Switching Time Waveform

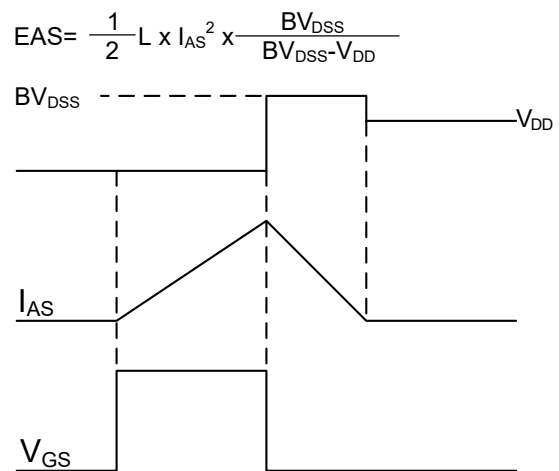

Fig.11 Unclamped Inductive Switching Wave

P-Ch Electrical Characteristics (T_J=25°C, unless otherwise noted)

Parameter	Symbol	Conditions	Min	Typ	Max	Unit
Drain-Source Breakdown Voltage	BV _{DSS}	V _{GS} =0V, I _D =-250uA	-40	---	---	V
BV _{DSS} Temperature Coefficient	ΔBV _{DSS} /ΔT _J	Reference to 25°C, I _D =-1mA	---	-0.012	---	V/°C
Static Drain-Source On-Resistance ²	R _{DS(ON)}	V _{GS} =-10V, I _D =-8A	---	---	45	mΩ
		V _{GS} =-4.5V, I _D =-4A	---	---	70	mΩ
Gate Threshold Voltage	V _{GS(th)}	V _{GS} =V _{DS} , I _D =-250uA	-1.0	---	-2.5	V
V _{GS(th)} Temperature Coefficient	ΔV _{GS(th)}		---	4.32	---	mV/°C
Drain-Source Leakage Current	I _{DSS}	V _{DS} =-32V, V _{GS} =0V, T _J =25°C	---	---	1	uA
		V _{DS} =-32V, V _{GS} =0V, T _J =25°C	---	---	5	uA
Gate-Source Leakage Current	I _{GSS}	V _{GS} =±20V, V _{DS} =0V	---	---	±100	nA
Forward Transconductance	g _{fs}	V _{DS} =-5V, I _D =-8A	---	12.6	---	S
Gate Resistance	R _g	V _{DS} =0V, V _{GS} =0V, f=1MHz	---	13	16	Ω
Total Gate Charge	Q _g	V _{DS} =-20V, V _{GS} =-4.5V, I _D =-12A	---	9	---	nC
Gate-Source Charge	Q _{gs}		---	2.54	---	
Gate-Drain Charge	Q _{gd}		---	3.1	---	
Turn-On Delay Time	T _{d(on)}	V _{DD} =-15V, V _{GS} =-10V, R _G =3.3Ω, I _D =-1A	---	19.2	---	ns
Rise Time	T _r		---	12.8	---	
Turn-Off Delay Time	T _{d(off)}		---	48.6	---	
Fall Time	T _f		---	4.6	---	
Input Capacitance	C _{iss}	V _{DS} =-15V, V _{GS} =0V, f=1MHz	---	1004	---	pF
Output Capacitance	C _{oss}		---	108	---	
Reverse Transfer Capacitance	C _{rss}		---	80	---	

Drain-Source Diode Characteristics

Parameter	Symbol	Conditions	Min	Typ	Max	Unit
Continuous Source Current ^{1,5}	I _S	V _G =V _D =0V, Force Current	---	---	-20	A
Pulsed Source Current ^{2,5}	I _{SM}		---	---	-40	A
Diode Forward Voltage ²	V _{SD}	V _{GS} =0V, I _S =-1A, T _J =25°C	---	---	-1	V

Note:

- 1.The data tested by surface mounted on a 1 inch² FR-4 board with 2OZ copper.
- 2.The data tested by pulsed, pulse width ≤ 300us, duty cycle ≤ 2%
- 3.The EAS data shows Max. rating. The test condition is V_{DD}=-25V, V_{GS}=-10V, L=0.1mH
- 4.The power dissipation is limited by 150°C junction temperature
- 5.The data is theoretically the same as I_D and I_{DM}, in real applications, should be limited by total power dissipation.

P-Ch Typical Characteristics

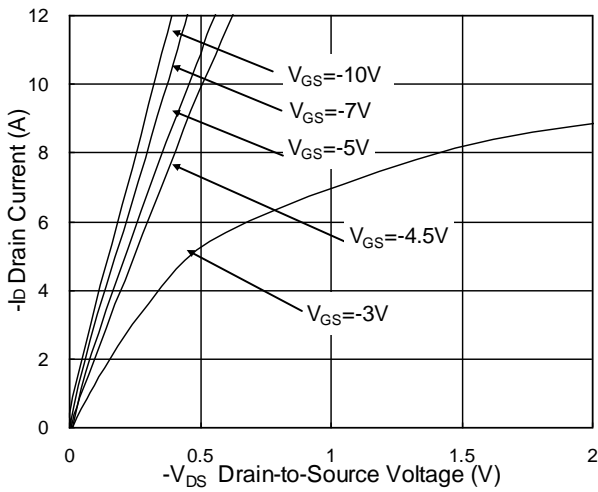

Fig.1 Typical Output Characteristics

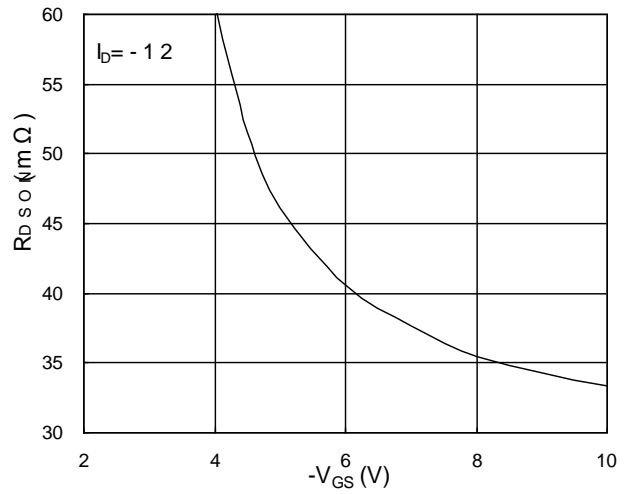

Fig.2 On-Resistance v.s Gate-Source

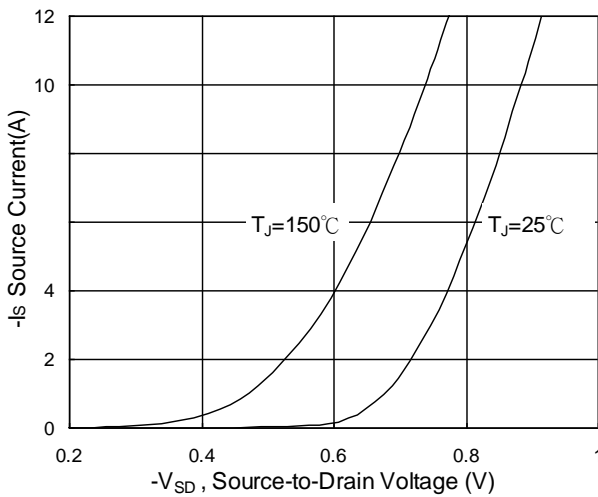

Fig.3 Forward Characteristics of Reverse

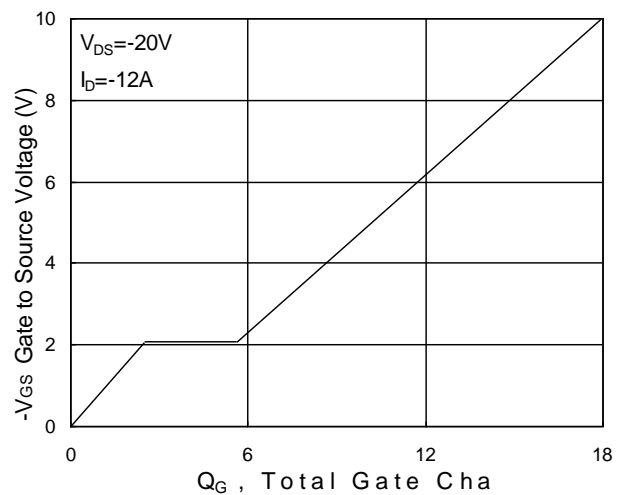

Fig.4 Gate-Charge Characteristics

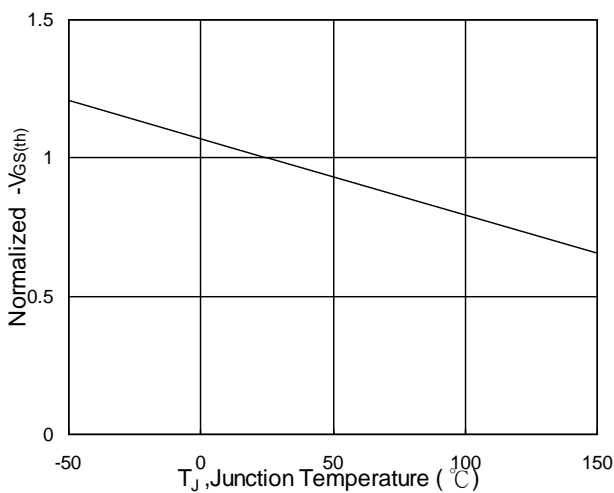

Fig.5 Normalized $V_{GS(th)}$ v.s T_J

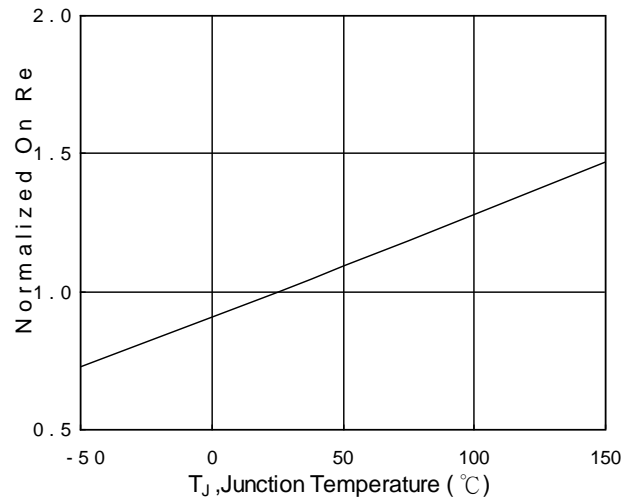

Fig.6 Normalized $R_{DS(on)}$ v.s T_J

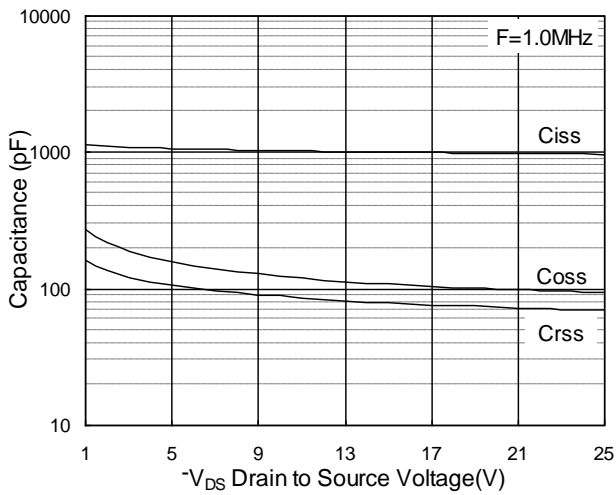

Fig.7 Capacitance

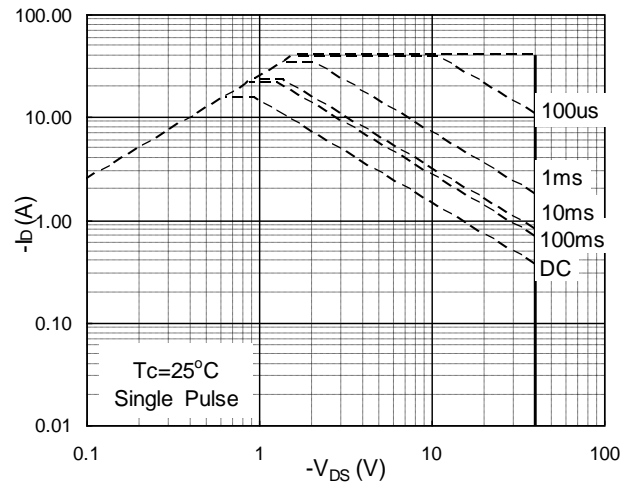

Fig.8 Safe Operating Area

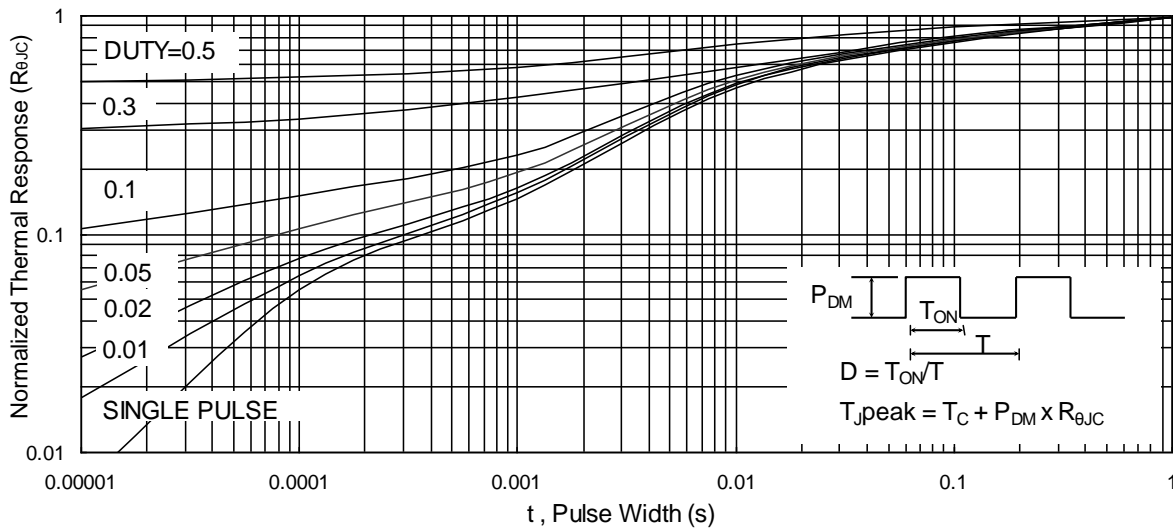

Fig.9 Normalized Maximum Transient Thermal Impedance

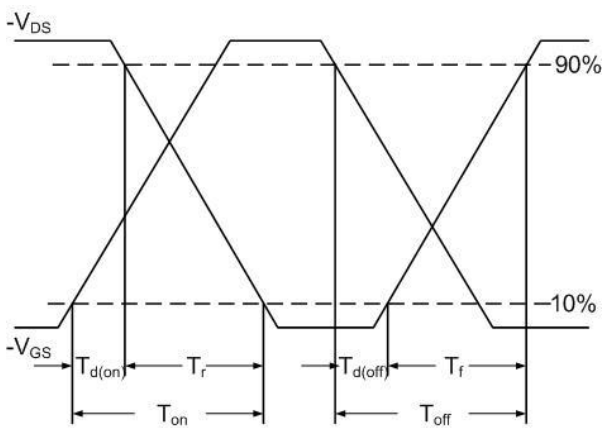

Fig.10 Switching Time Waveform

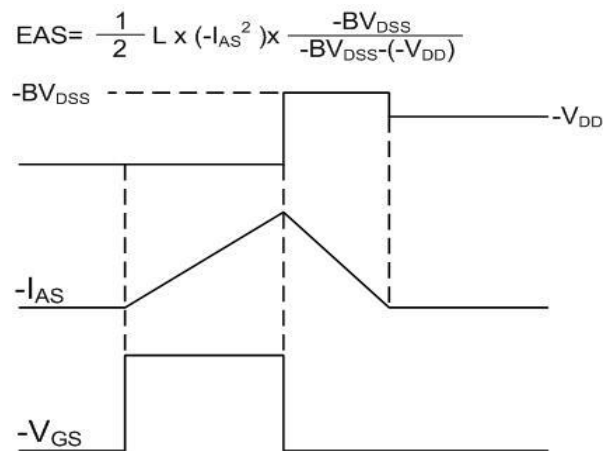
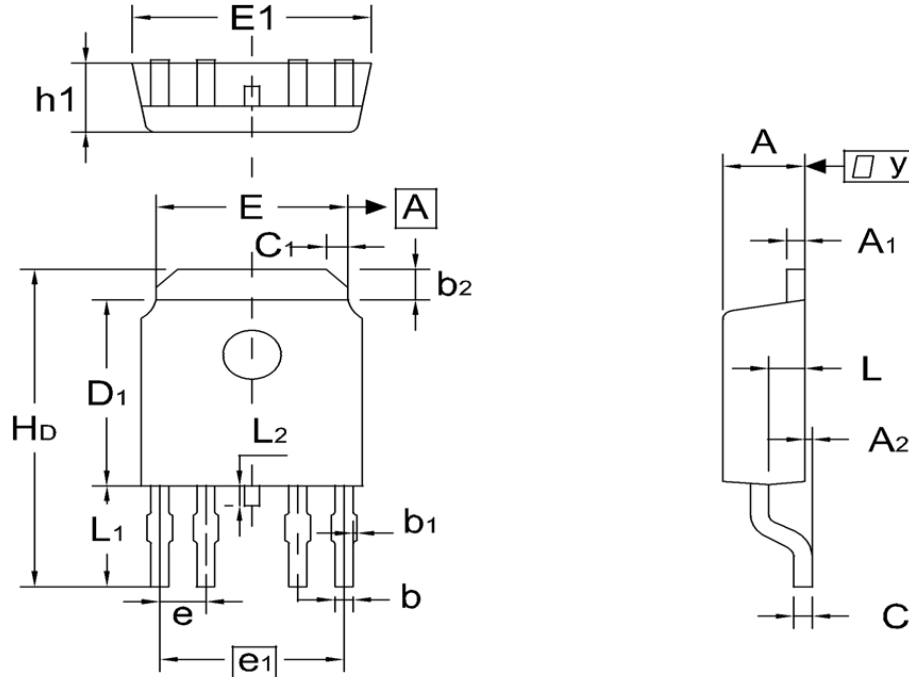

Fig.11 Unclamped Inductive Waveform

TO-252-4L Package Outline Dimensions



DIMENSIONS (unit : mm)

Symbol	Min	Typ	Max	Symbol	Min	Typ	Max
A	2.1	2.3	2.5	A ₁	0.4	0.5	0.6
A ₂	--	--	0.3	b	0.4	0.5	0.6
b ₁	--	--	0.1	b ₂	0.8	1.0	1.2
C	0.4	0.5	0.6	C ₁	0.4	0.6	0.8
D ₁	5.7	6.1	6.5	E	5.0	5.3	5.6
E ₁	6.3	6.6	6.9	e	--	1.27	--
e ₁	--	5.08	--	H _D	9.6	10.0	10.4
h ₁	2.1	2.3	2.5	L	0.80	1.0	1.2
L ₁	2.6	2.9	3.2	L ₂	0.35	0.65	0.95