

Features

- Advanced high cell density Trench technology
- Super Low Gate Charge
- Excellent CdV/dt effect decline
- 100% EAS Guaranteed
- Green Device Available

Product Summary



V_{DS}	40	V
I_D	120	A
$R_{DS(ON)}$ (at $V_{GS}=10V$)	4	m Ω
$R_{DS(ON)}$ (at $V_{GS}=4.5V$)	7	m Ω

Applications

- High Frequency Point-of-Load Synchronous Buck Converter
- Networking DC-DC Power System
- Load Switch, Uninterruptible power supply



Absolute Maximum Ratings($T_C=25^{\circ}C$, unless otherwise noted)

Parameter	Symbol	Rating	Units
Drain-Source Voltage	V_{DS}	40	V
Gate-Source Voltage	V_{GS}	± 20	V
Continuous Drain Current	$I_D@T_C=25^{\circ}C$	120	A
Continuous Drain Current	$I_D@T_C=100^{\circ}C$	85	A
Pulsed Drain Current	I_{DM}	330	A
Single Pulse Avalanche Energy ³	EAS	1080	mJ
Total Power Dissipation	$P_D@T_C=25^{\circ}C$	120	W
Derating factor		0.8	W/ $^{\circ}C$
Storage Temperature Range	T_{STG}	-55 to 175	$^{\circ}C$
Operating Junction Temperature Range	T_J	-55 to 175	$^{\circ}C$

Thermal Characteristics

Parameter	Symbol	Typ	Max	Unit
Thermal Resistance Junction-Case ¹	$R_{\theta JC}$	---	1.25	$^{\circ}C/W$

Electrical Characteristics ($T_J=25^{\circ}\text{C}$, unless otherwise noted)

Parameter	Symbol	Conditions	Min	Typ	Max	Unit
Drain-Source Breakdown Voltage	BV_{DSS}	$V_{GS}=0V, I_D=250\mu A$	40	45	---	V
Static Drain-Source On-Resistance	$R_{DS(ON)}$	$V_{GS}=10V, I_D=20A$	---	3.6	4	$m\Omega$
		$V_{GS}=4.5V, I_D=10A$	---	5.8	7	$m\Omega$
Gate Threshold Voltage	$V_{GS(th)}$	$V_{GS}=V_{DS}, I_D=250\mu A$	1.2	1.8	2.5	V
Drain-Source Leakage Current	I_{DSS}	$V_{DS}=40V, V_{GS}=0V, T_J=25^{\circ}\text{C}$	---	---	1	μA
Gate-Source Leakage Current	I_{GSS}	$V_{GS}=\pm 20V, V_{DS}=0V$	---	---	± 100	nA
Forward Transconductance	g_{fs}	$V_{DS}=10V, I_D=20A$	26	---	---	S
Total Gate Charge	Q_g	$V_{DS}=20V, V_{GS}=10V, I_D=20A$	---	75	---	nC
Gate-Source Charge	Q_{gs}		---	10.5	---	
Gate-Drain Charge	Q_{gd}		---	17	---	
Turn-On Delay Time	$T_{d(on)}$	$V_{DD}=20V, I_D=2A, V_{GS}=10V, R_G=3\Omega, R_L=1\Omega$	---	15	---	ns
Rise Time	T_r		---	18	---	
Turn-Off Delay Time	$T_{d(off)}$		---	52	---	
Fall Time	T_f		---	23	---	
Input Capacitance	C_{iss}	$V_{DS}=20V, V_{GS}=0V, f=1\text{MHz}$	---	5400	---	pF
Output Capacitance	C_{oss}		---	970	---	
Reverse Transfer Capacitance	C_{rss}		---	380	---	

Drain-Source Diode Characteristics

Parameter	Symbol	Conditions	Min	Typ	Max	Unit
Continuous Source Current ¹	I_S		---	---	120	A
Diode Forward Voltage ²	V_{SD}	$V_{GS}=0V, I_S=40A, T_J=25^{\circ}\text{C}$	---	---	1.2	V
Reverse Recovery Time	t_{rr}	$I_F=40A, di/dt=100A/\mu s, T_J=25^{\circ}\text{C}$	---	42	---	nS
Reverse Recovery Charge	Q_{rr}		---	45	---	nC
Forward Turn-On Time	t_{on}	Intrinsic turn-on time is negligible (turn-on is dominated by LS+LD)				

Note:

- 1.The data tested by surface mounted on a 1 inch² FR-4 board with 2OZ copper.
- 2.The data tested by pulsed , pulse width $\leq 300\mu s$, duty cycle $\leq 2\%$
- 3.The EAS data shows Max. rating . The test condition is $V_{DD}=20V, V_{GS}=10V, L=1mH, R_G=25\Omega$
- 4.The power dissipation is limited by 175 $^{\circ}\text{C}$ junction temperature

Typical Characteristics

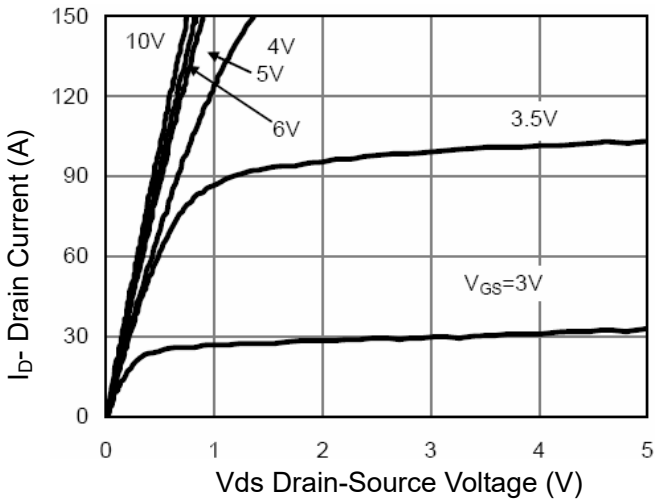

Figure 1 Output Characteristics

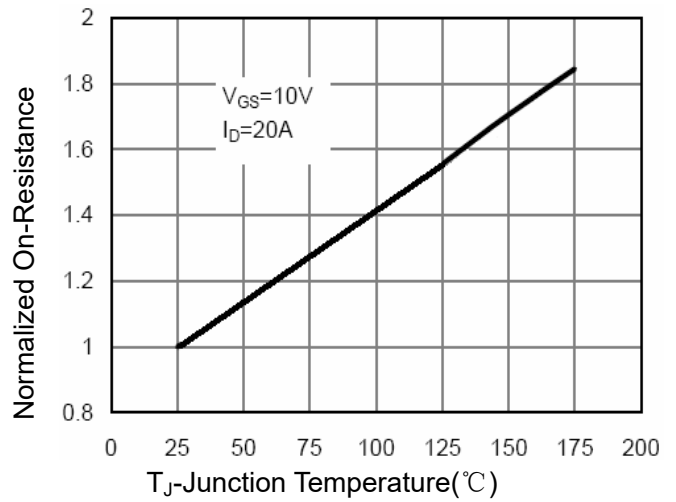

Figure 4 Rdson-Junction Temperature

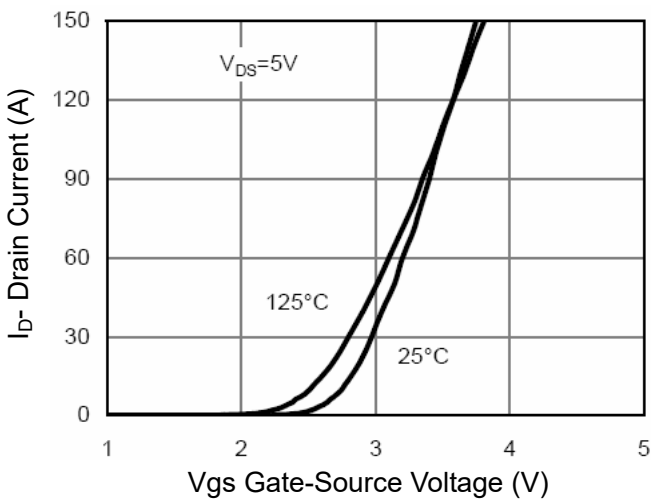

Figure 2 Transfer Characteristics

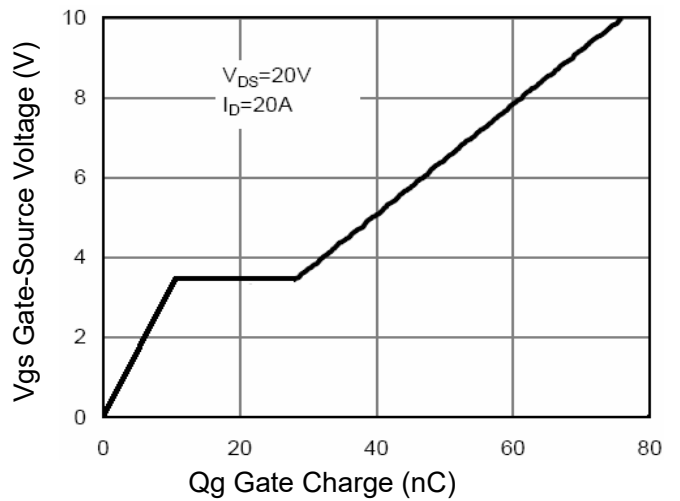

Figure 5 Gate Charge

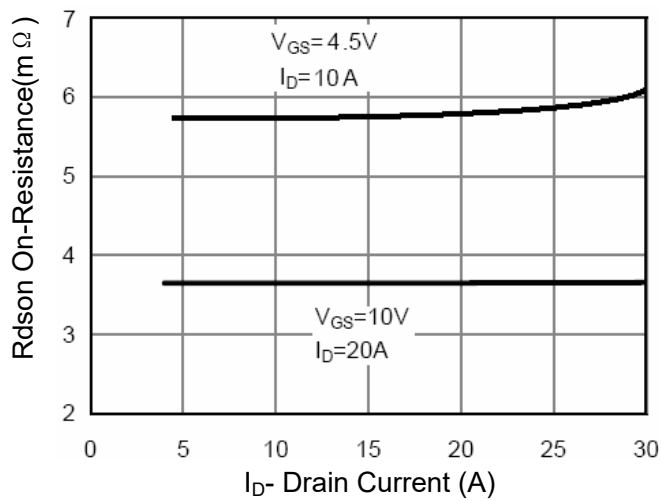

Figure 3 Rdson- Drain Current

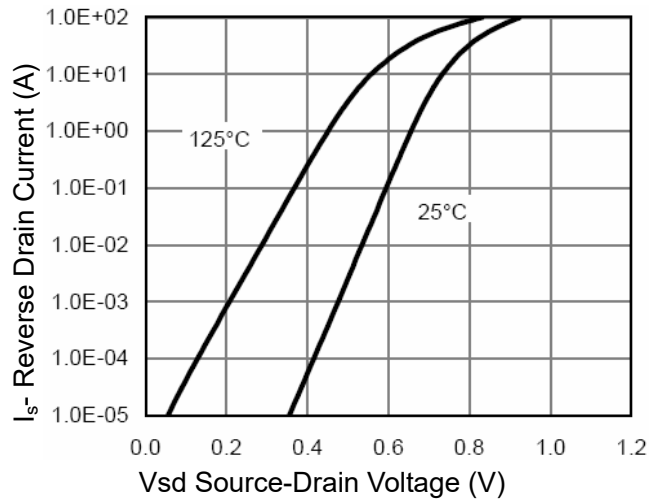

Figure 6 Source- Drain Diode Forward

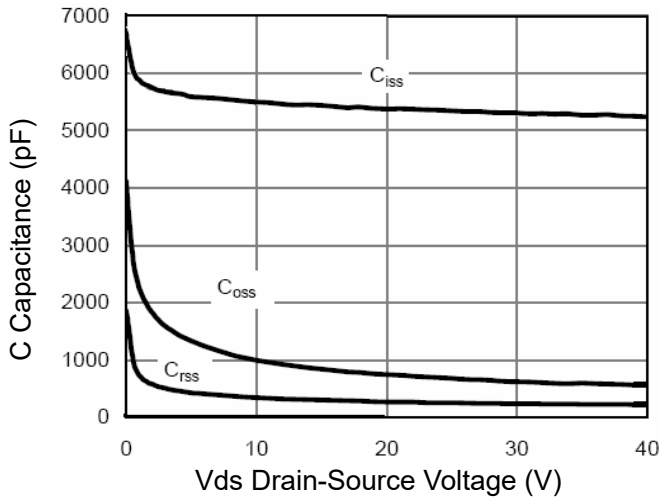

Figure 7 Capacitance vs Vds

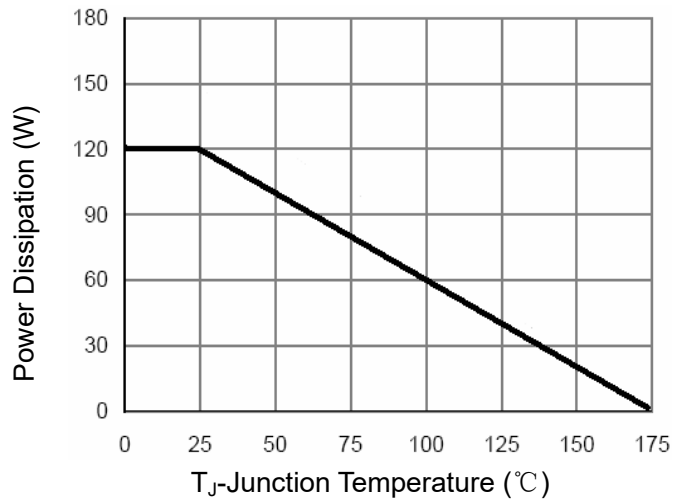

Figure 9 Power De-rating

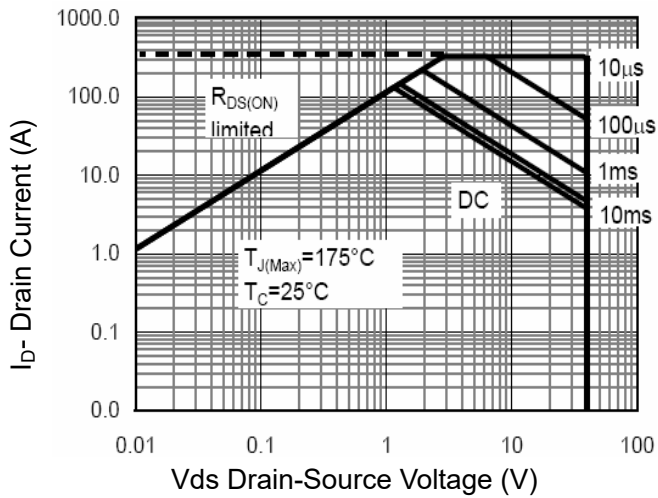

Figure 8 Safe Operation Area

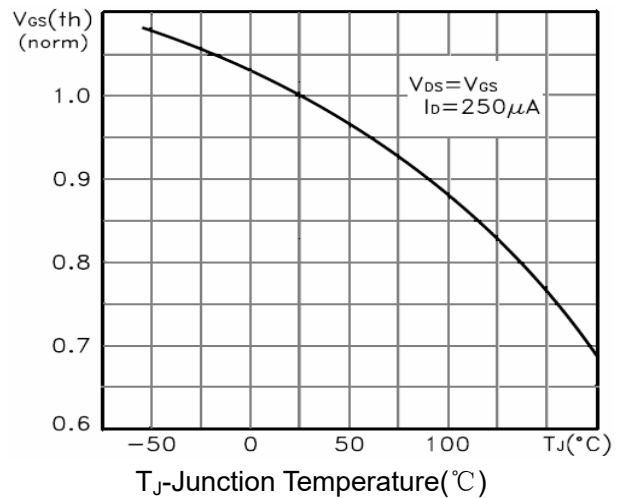

Figure 10 V_{GS(th)} vs Junction Temperature

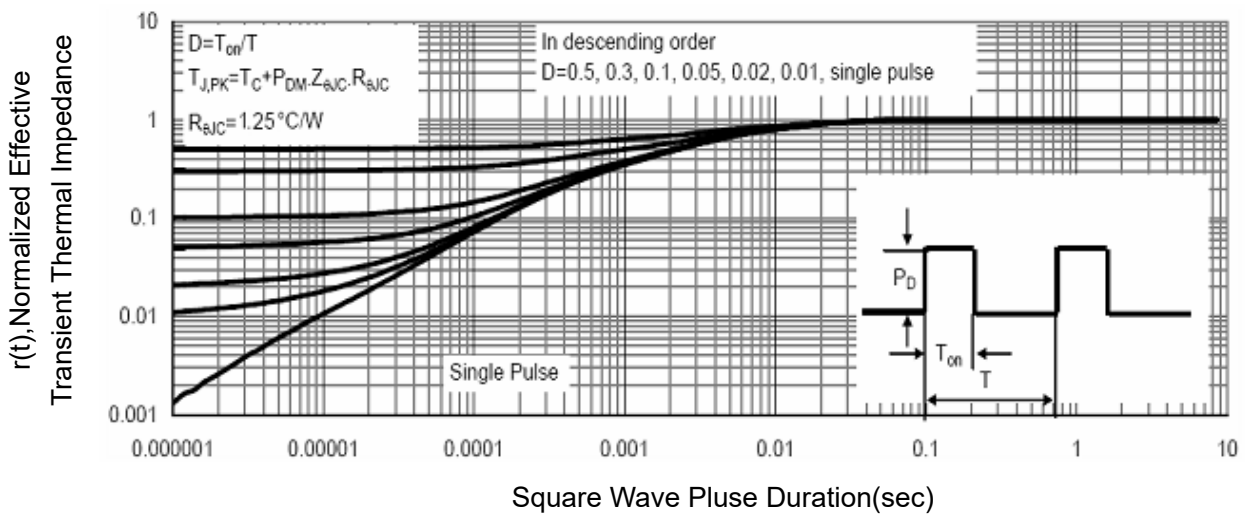
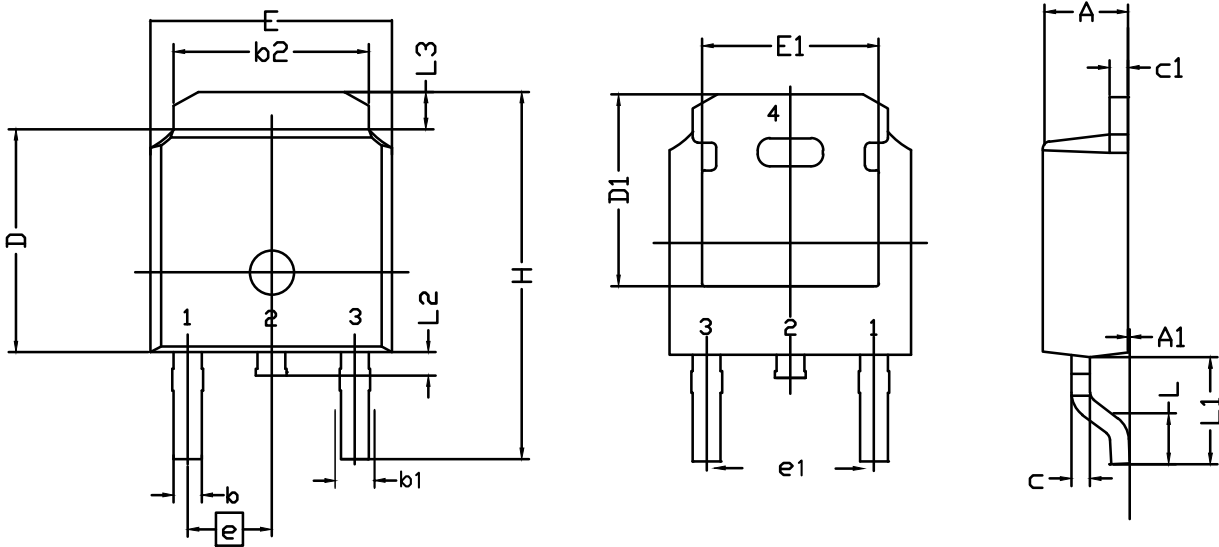

Figure 11 Normalized Maximum Transient Thermal Impedance

TO-252 Package Outline Dimensions



Symbol	Dimensions (unit:mm)			Symbol	Dimensions (unit:mm)		
	Min	Typ	Max		Min	Typ	Max
A	2.20	2.30	2.38	E	6.40	6.60	6.731
A ₁	0.00	0.10	0.20	E ₁	4.40	--	--
b	0.64	0.76	0.89	e	2.286 BSC		
b ₁	0.77	0.85	1.14	e ₁	4.572 BSC		
b ₂	5.00	5.33	5.46	H	9.40	10.00	10.40
c	0.458	0.508	0.610	L	1.40	1.52	1.77
C ₁	0.458	0.508	0.620	L ₁	--	2.743	--
D	5.98	6.10	6.223	L ₂	0.60	0.80	1.01
D ₁	5.20	5.25	5.38	L ₃	0.90	1.06	1.25