

Features

- Advanced high cell density Trench technology
- Super Low Gate Charge
- Excellent CdV/dt effect decline
- 100% EAS Guaranteed
- Green Device Available

Applications

- High Frequency Point-of-Load Synchronous Buck Converter
- Networking DC-DC Power System
- Load Switch

Product Summary



V_{DS}	60	V
I_D	23	A
$R_{DS(ON)}$ (at $V_{GS}=10V$)	30	m Ω
$R_{DS(ON)}$ (at $V_{GS}=4.5V$)	38	m Ω

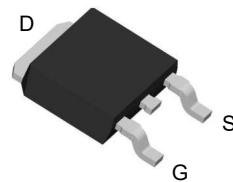

TO-252 Top View

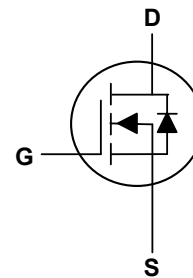

Absolute Maximum Ratings($T_C=25^\circ\text{C}$, unless otherwise noted)

Parameter	Symbol	Rating	Units
Drain-Source Voltage	V_{DS}	60	V
Gate-Source Voltage	V_{GS}	± 20	V
Continuous Drain Current, V_{GS} @ 10V ¹	$I_D@T_C=25^\circ\text{C}$	23	A
Continuous Drain Current, V_{GS} @ 10V ¹	$I_D@T_C=100^\circ\text{C}$	15	A
Continuous Drain Current, V_{GS} @ 10V ¹	$I_D@T_A=25^\circ\text{C}$	5.6	A
Continuous Drain Current, V_{GS} @ 10V ¹	$I_D@T_A=70^\circ\text{C}$	4.5	A
Pulsed Drain Current ²	I_{DM}	46	A
Single Pulse Avalanche Energy ³	EAS	25.5	mJ
Avalanche Current	I_{AS}	22.6	A
Total Power Dissipation ⁴	$P_D@T_C=25^\circ\text{C}$	34.7	W
Total Power Dissipation ⁴	$P_D@T_A=25^\circ\text{C}$	2	W
Storage Temperature Range	T_{STG}	-55 to 150	$^\circ\text{C}$
Operating Junction Temperature Range	T_J	-55 to 150	$^\circ\text{C}$

Thermal Characteristics

Parameter	Symbol	Typ	Max	Unit
Thermal Resistance Junction-Ambient ¹	$R_{\theta JA}$	---	62	$^\circ\text{C}/\text{W}$
Thermal Resistance Junction-Case ¹	$R_{\theta JC}$	---	3.6	$^\circ\text{C}/\text{W}$

Electrical Characteristics (T_J=25°C, unless otherwise noted)

Parameter	Symbol	Conditions	Min	Typ	Max	Unit
Drain-Source Breakdown Voltage	BV _{DSS}	V _{GS} =0V, I _D =250uA	60	---	---	V
BV _{DSS} Temperature Coefficient	ΔBV _{DSS} /ΔT _J	Reference to 25°C, I _D =1mA	---	0.063	---	V/°C
Static Drain-Source On-Resistance ²	R _{DS(ON)}	V _{GS} =10V, I _D =15A	---	25	30	mΩ
		V _{GS} =4.5V, I _D =10A	---	30	38	mΩ
Gate Threshold Voltage	V _{GS(th)}	V _{GS} =V _{DS} , I _D =250uA	1.2	---	2.5	V
V _{GS(th)} Temperature Coefficient	ΔV _{GS(th)}		---	-5.24	---	mV/°C
Drain-Source Leakage Current	I _{DSS}	V _{DS} =48V, V _{GS} =0V, T _J =25°C	---	---	1	uA
		V _{DS} =48V, V _{GS} =0V, T _J =55°C	---	---	5	
Gate-Source Leakage Current	I _{GSS}	V _{GS} =±20V, V _{DS} =0V	---	---	±100	nA
Forward Transconductance	g _{fs}	V _{DS} =5V, I _D =15A	---	17	---	S
Gate Resistance	R _g	V _{DS} =0V, V _{GS} =0V, f=1MHz	---	3.2	---	Ω
Total Gate Charge	Q _g	V _{DS} =48V, V _{GS} =4.5V, I _D =12A	---	12.6	---	nC
Gate-Source Charge	Q _{gs}		---	3.2	---	
Gate-Drain Charge	Q _{gd}		---	6.3	---	
Turn-On Delay Time	T _{d(on)}	V _{DD} =30V, V _{GS} =10V, R _G =3.3Ω, I _D =10A	---	8	---	ns
Rise Time	T _r		---	14.2	---	
Turn-Off Delay Time	T _{d(off)}		---	24.4	---	
Fall Time	T _f		---	4.6	---	
Input Capacitance	C _{iss}	V _{DS} =15V, V _{GS} =0V, f=1MHz	---	1378	---	pF
Output Capacitance	C _{oss}		---	86	---	
Reverse Transfer Capacitance	C _{rss}		---	64	---	

Drain-Source Diode Characteristics

Parameter	Symbol	Conditions	Min	Typ	Max	Unit
Continuous Source Current ^{1,5}	I _S	V _G =V _D =0V, Force Current	---	---	23	A
Pulsed Source Current ^{2,5}	I _{SM}		---	---	46	A
Diode Forward Voltage ²	V _{SD}	V _{GS} =0V, I _S =1A, T _J =25°C	---	---	1.2	V

Note:

- The data tested by surface mounted on a 1 inch² FR-4 board with 2OZ copper.
- The data tested by pulsed, pulse width ≤ 300us, duty cycle ≤ 2%
- The EAS data shows Max. rating. The test condition is V_{DD}=25V, V_{GS}=10V, L=0.1mH
- The power dissipation is limited by 150°C junction temperature
- The data is theoretically the same as I_D and I_{DM}, in real applications, should be limited by total power dissipation.

Typical Characteristics

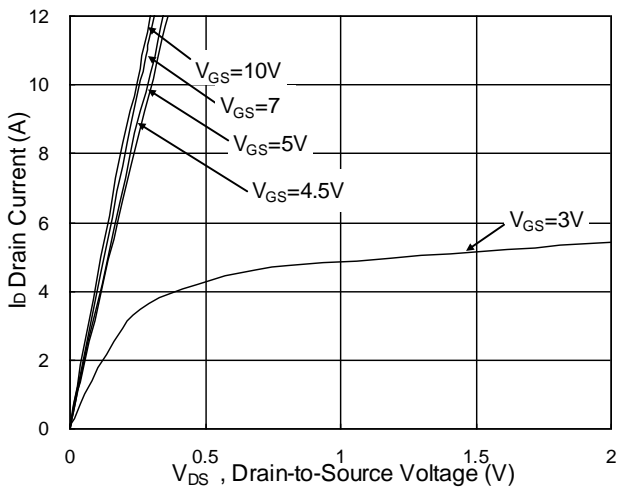

Fig.1 Typical Output Characteristics

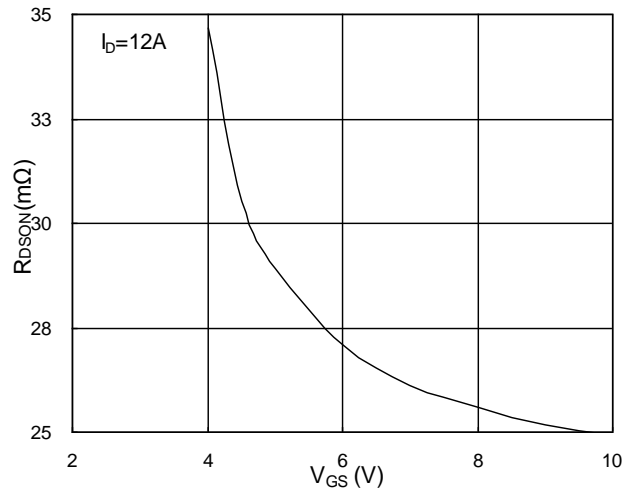

Fig.2 On-Resistance v.s Gate-Source

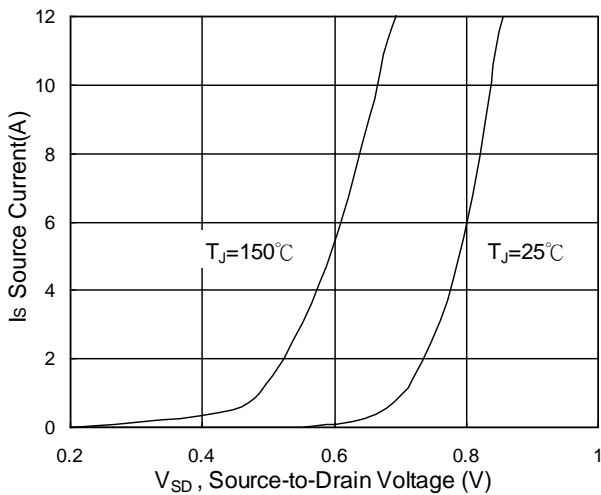

Fig.3 Forward Characteristics of Reverse

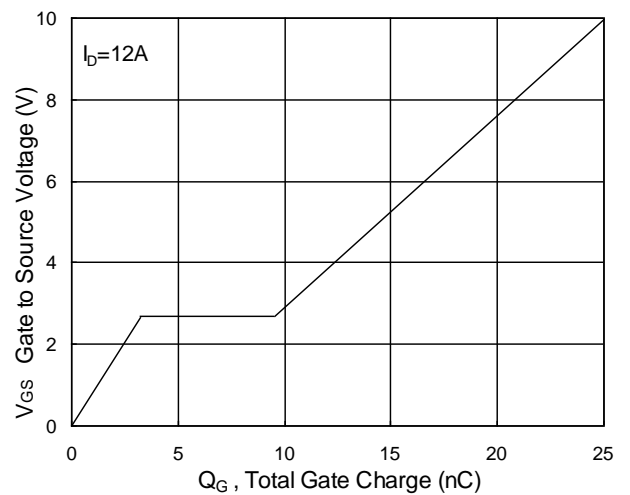

Fig.4 Gate-Charge Characteristics

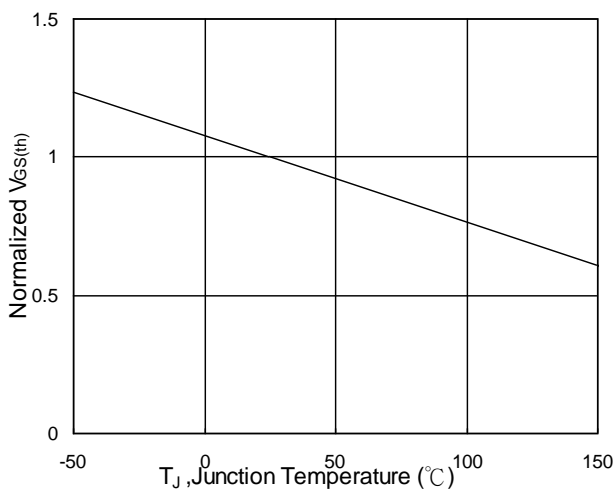

Fig.5 Normalized $V_{GS(th)}$ v.s T_J

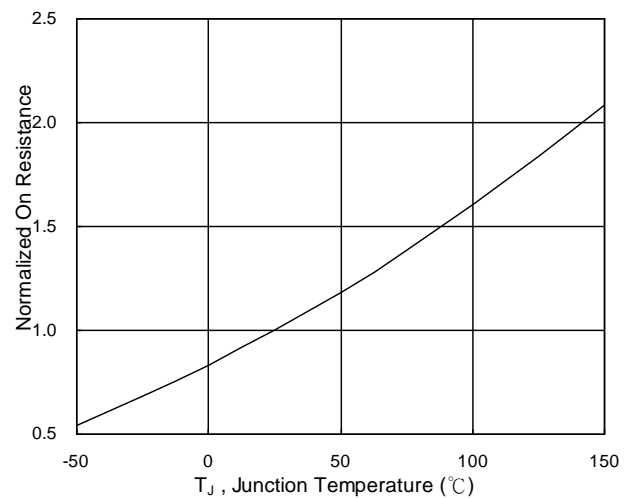

Fig.6 Normalized $R_{DS(on)}$ v.s T_J

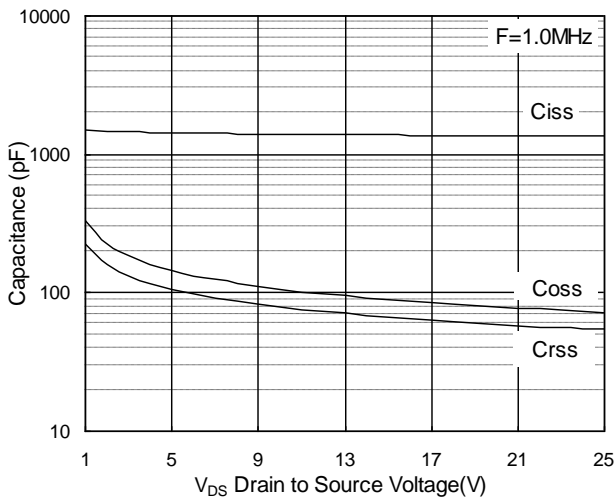

Fig.7 Capacitance

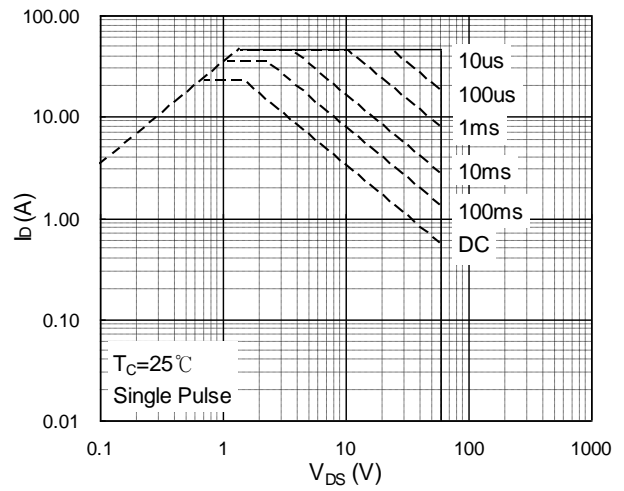

Fig.8 Safe Operating Area

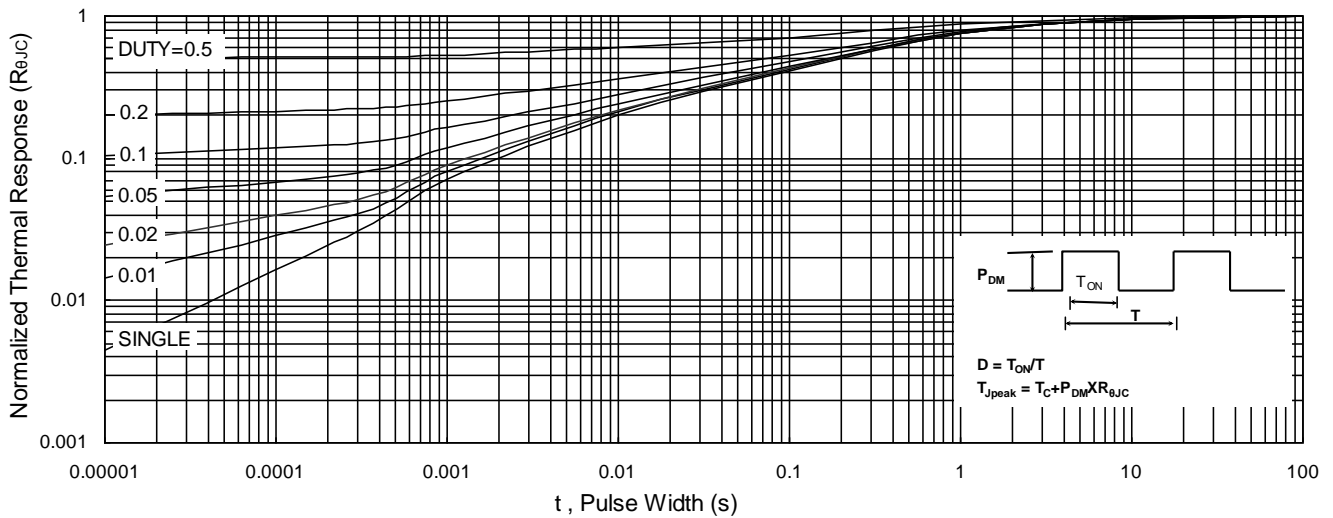

Fig.9 Normalized Maximum Transient Thermal Impedance

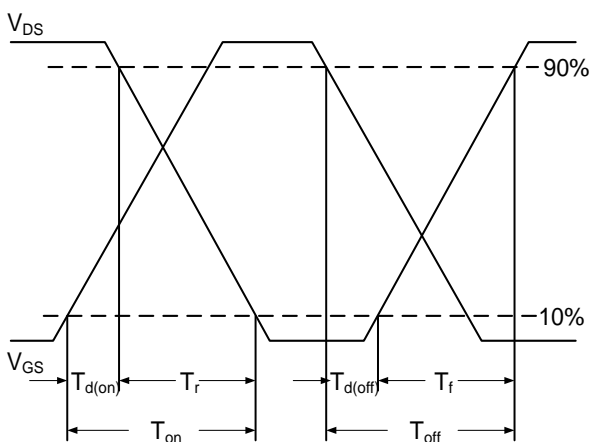

Fig.10 Switching Time Waveform

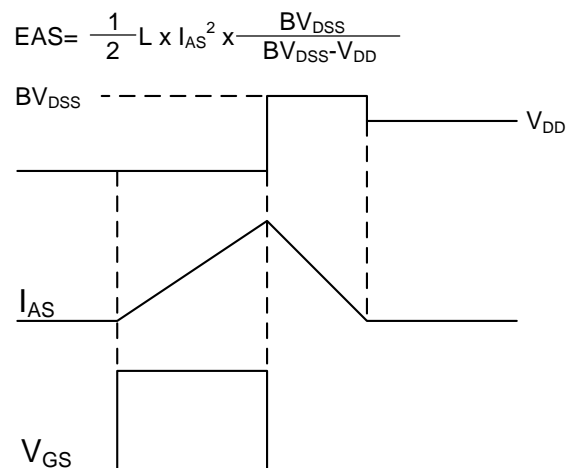
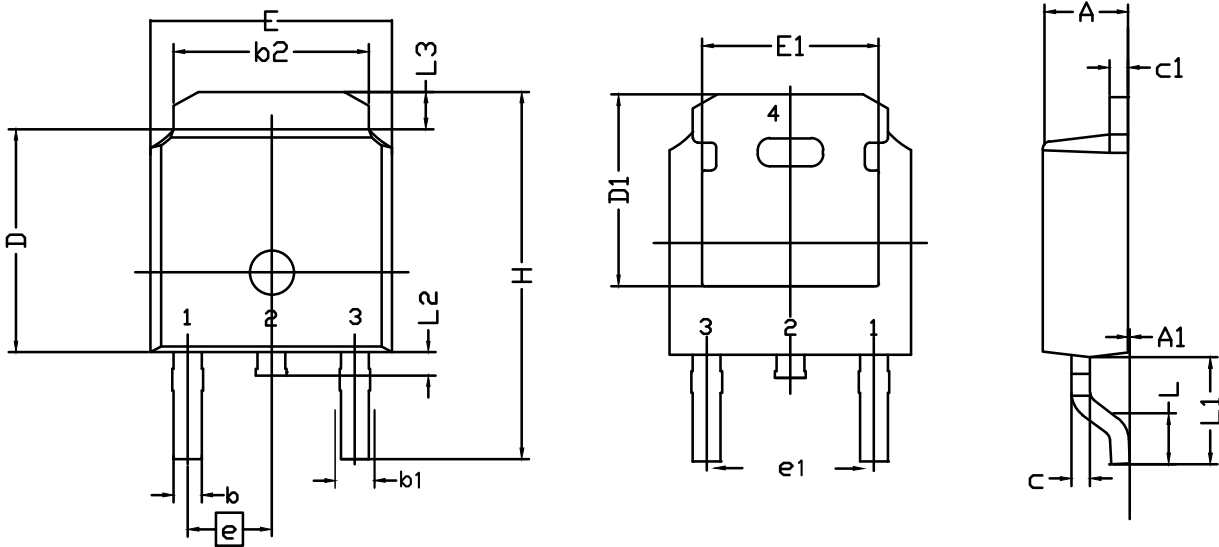

Fig.11 Unclamped Inductive Waveform

TO-252 Package Outline Dimensions



Symbol	Dimensions (unit:mm)			Symbol	Dimensions (unit:mm)		
	Min	Typ	Max		Min	Typ	Max
A	2.20	2.30	2.38	E	6.40	6.60	6.731
A₁	0.00	0.10	0.20	E₁	4.40	--	--
b	0.64	0.76	0.89	e	2.286 BSC		
b₁	0.77	0.85	1.14	e₁	4.572 BSC		
b₂	5.00	5.33	5.46	H	9.40	10.00	10.40
c	0.458	0.508	0.610	L	1.40	1.52	1.77
C₁	0.458	0.508	0.620	L₁	--	2.743	--
D	5.98	6.10	6.223	L₂	0.60	0.80	1.01
D₁	5.20	5.25	5.38	L₃	0.90	1.06	1.25