

Features

- Advanced high cell density Trench technology
- Super Low Gate Charge
- Excellent CdV/dt effect decline
- 100% EAS Guaranteed
- Green Device Available

Applications

- High Frequency Point-of-Load, Synchronous Buck Converter
- Networking DC-DC Power System
- Load Switch

Product Summary



V_{DS}	30	V
I_D	115	A
$R_{DS(ON)}$ (at $V_{GS}=10V$)	2.5	m Ω
$R_{DS(ON)}$ (at $V_{GS}=4.5V$)	3.6	m Ω

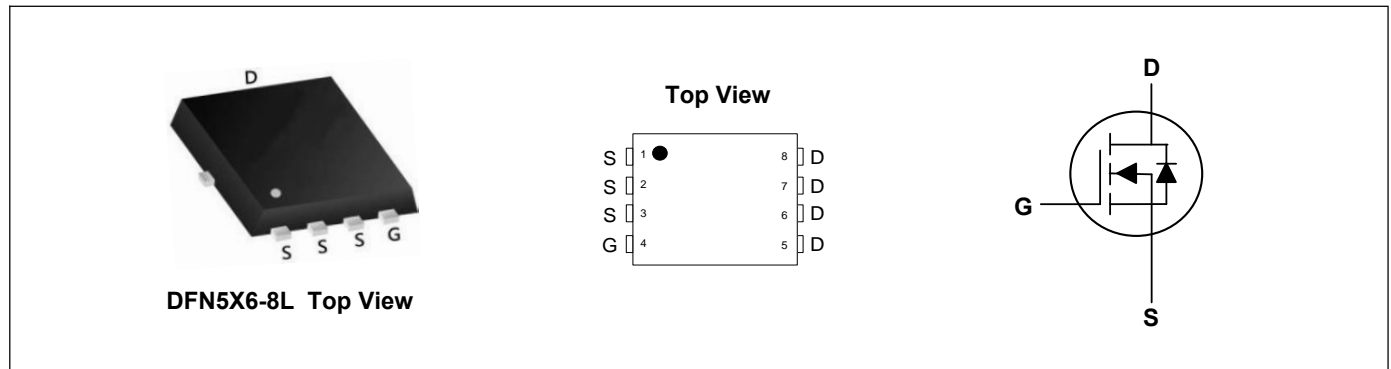

Absolute Maximum Ratings ($T_C=25^\circ\text{C}$, unless otherwise noted)

Parameter	Symbol	Rating	Units
Drain-Source Voltage	V_{DS}	30	V
Gate-Source Voltage	V_{GS}	± 20	V
Continuous Drain Current ¹	$I_D@T_C=25^\circ\text{C}$	115	A
Continuous Drain Current ¹	$I_D@T_C=100^\circ\text{C}$	73	A
Pulsed Drain Current ²	I_{DM}	141	A
Single Pulse Avalanche Energy ³	EAS	101	mJ
Avalanche Current	I_{AS}	45	A
Total Power Dissipation ⁴	$P_D@T_C=25^\circ\text{C}$	50	W
Storage Temperature Range	T_{STG}	-55 to 150	$^\circ\text{C}$
Operating Junction Temperature Range	T_J	-55 to 150	$^\circ\text{C}$

Thermal Characteristics

Parameter	Symbol	Typ	Max	Unit
Thermal Resistance Junction-Ambient ¹	$R_{\theta JA}$	---	50	$^\circ\text{C/W}$
Thermal Resistance Junction-Case ¹	$R_{\theta JC}$	---	2.5	$^\circ\text{C/W}$

Electrical Characteristics ($T_J=25^{\circ}\text{C}$, unless otherwise noted)

Parameter	Symbol	Conditions	Min	Typ	Max	Unit
Drain-Source Breakdown Voltage	BV_{DSS}	$V_{GS}=0V, I_D=250\mu A$	30	---	---	V
Static Drain-Source On-Resistance	$R_{DS(ON)}$	$V_{GS}=10V, I_D=20A$	---	2.1	2.5	$m\Omega$
		$V_{GS}=4.5V, I_D=15A$	---	2.8	3.6	$m\Omega$
Gate Threshold Voltage	$V_{GS(th)}$	$V_{GS}=V_{DS}, I_D=250\mu A$	1	1.5	2	V
Drain-Source Leakage Current	I_{DSS}	$V_{DS}=24V, V_{GS}=0V$	---	---	1	μA
Gate-Source Leakage Current	I_{GSS}	$V_{GS}=\pm 20V, V_{DS}=0V$	---	---	± 100	nA
Forward Transconductance	g_{fs}	$V_{DS}=5V, I_D=20A$	---	38	---	S
Gate Resistance	R_g	$V_{DS}=0V, V_{GS}=0V, f=1MHz$	---	2.6	---	Ω
Total Gate Charge	Q_g	$V_{DS}=25V, V_{GS}=10V, I_D=14A$	---	88	---	nC
Gate-Source Charge	Q_{gs}		---	8.7	---	
Gate-Drain Charge	Q_{gd}		---	24	---	
Turn-On Delay Time	$T_{d(on)}$	$V_{DD}=15V, V_{GS}=10V, R_G=2.5\Omega, I_D=1A$	---	33	---	ns
Rise Time	T_r		---	23	---	
Turn-Off Delay Time	$T_{d(off)}$		---	70	---	
Fall Time	T_f		---	25	---	
Input Capacitance	C_{iss}	$V_{DS}=15V, V_{GS}=0V, f=1MHz$	---	4240	---	pF
Output Capacitance	C_{oss}		---	490	---	
Reverse Transfer Capacitance	C_{rss}		---	320	---	

Drain-Source Diode Characteristics

Parameter	Symbol	Conditions	Min	Typ	Max	Unit
Diode Forward Voltage ²	V_{SD}	$V_{GS}=0V, I_S=15A$	---	0.7	1.1	V
Reverse Recovery Time	t_{rr}	$I_F=15A, V_{GS}=0V$ $di/dt=100A/\mu s, T_J=25^{\circ}\text{C}$	---	20	---	nS
Reverse Recovery Charge	Q_{rr}		---	8.7	---	nC

Note:

- 1.The data tested by surface mounted on a 1 inch² FR-4 board with 2OZ copper.
- 2.The data tested by pulsed , pulse width $\leq 300\mu s$, duty cycle $\leq 2\%$
- 3.The EAS data shows Max. rating . The test condition is $V_{DD}=15V, V_{GS}=10V, L=0.1mH$
- 4.The power dissipation is limited by 150°C junction temperature

Typical Characteristics

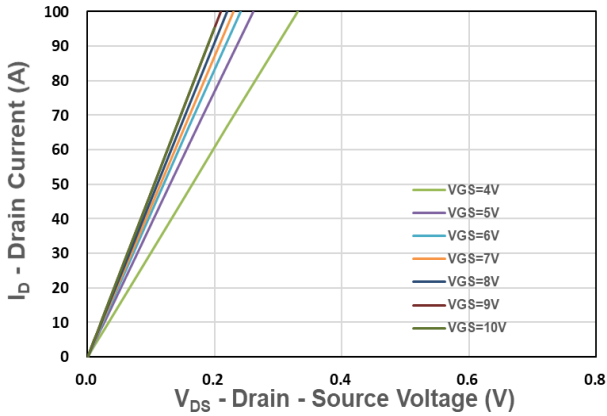

Figure 1. Output Characteristics

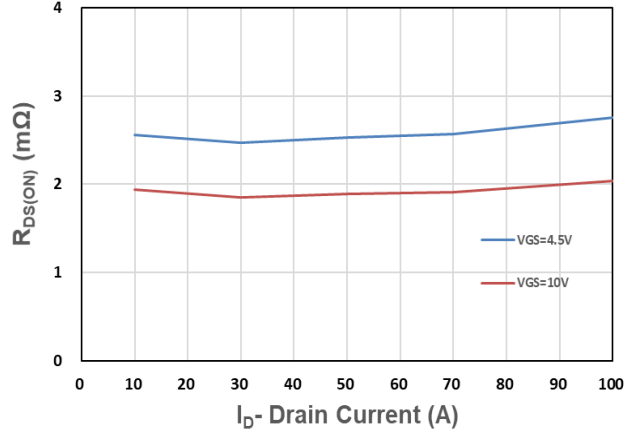

Figure 2. On-Resistance vs. ID

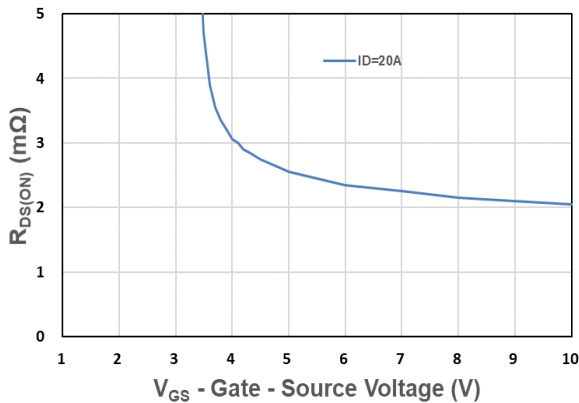

Figure 3. On-Resistance vs. VGS

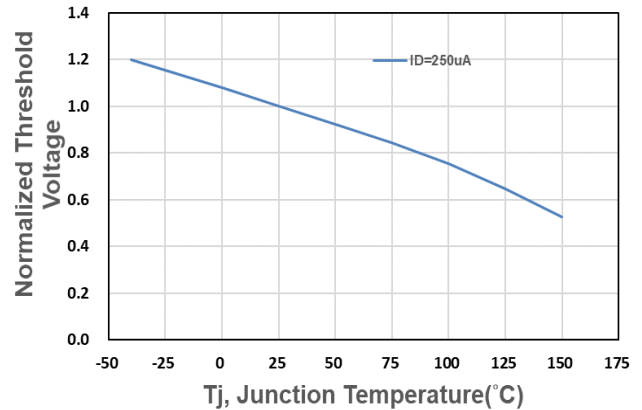

Figure 4. Gate Threshold Voltage

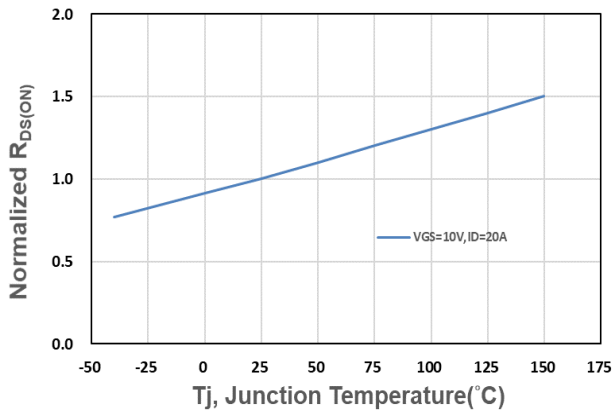

Figure 5. Drain-Source On Resistance

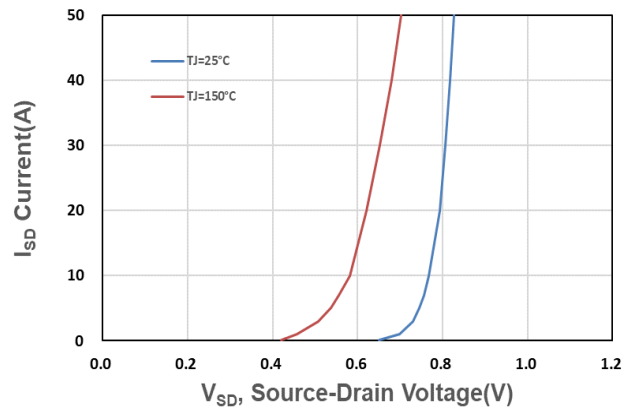

Figure 6. Source-Drain Diode Forward

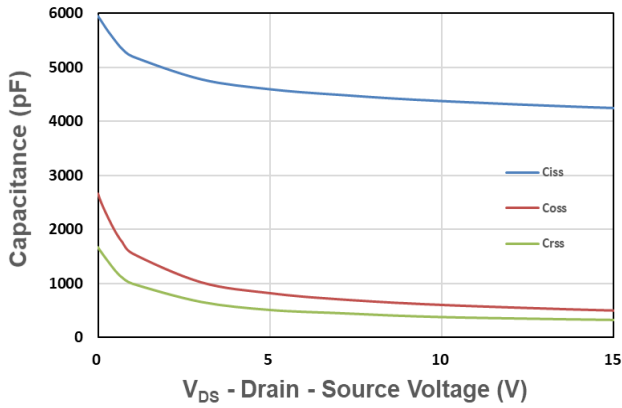

Figure 7. Capacitance

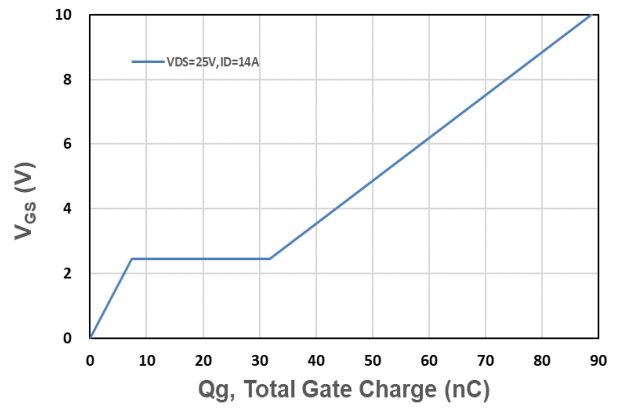

Figure 8. Gate Charge Characteristics

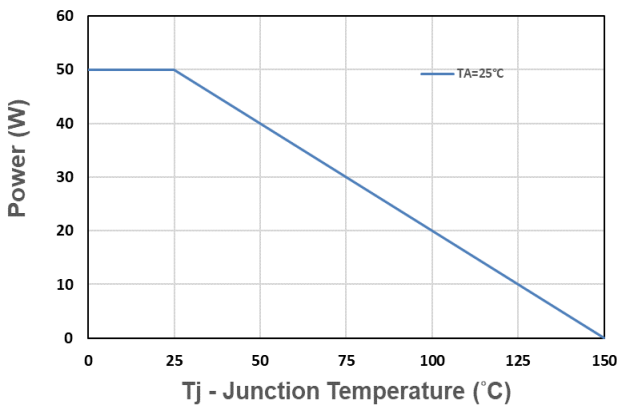

Figure 9. Power Dissipation

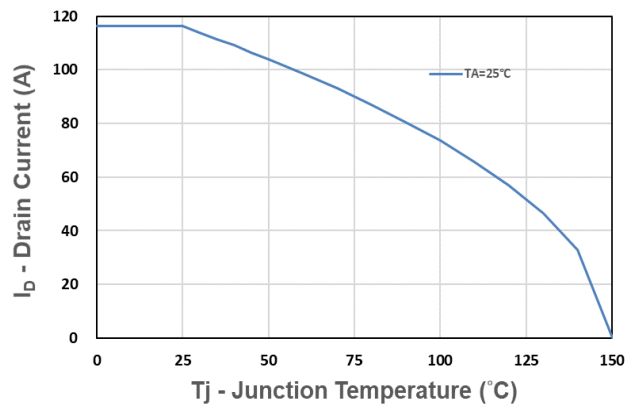

Figure 10. Drain Current

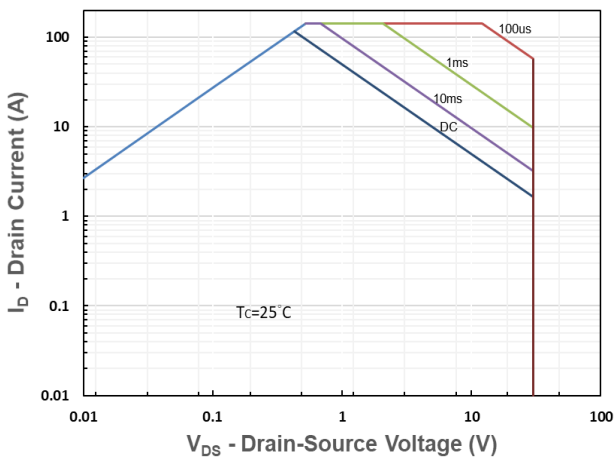

Figure 11. Safe Operating Area

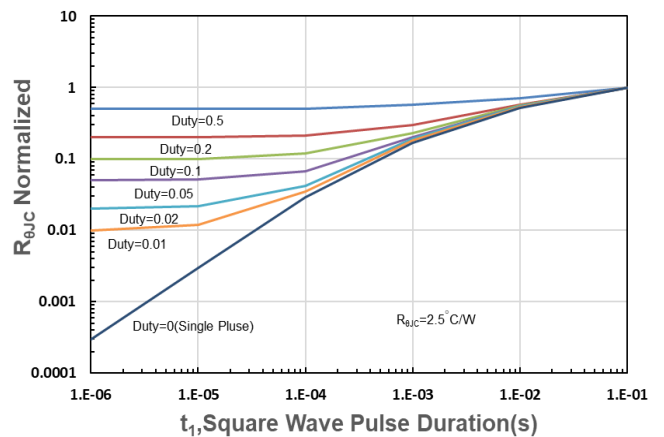
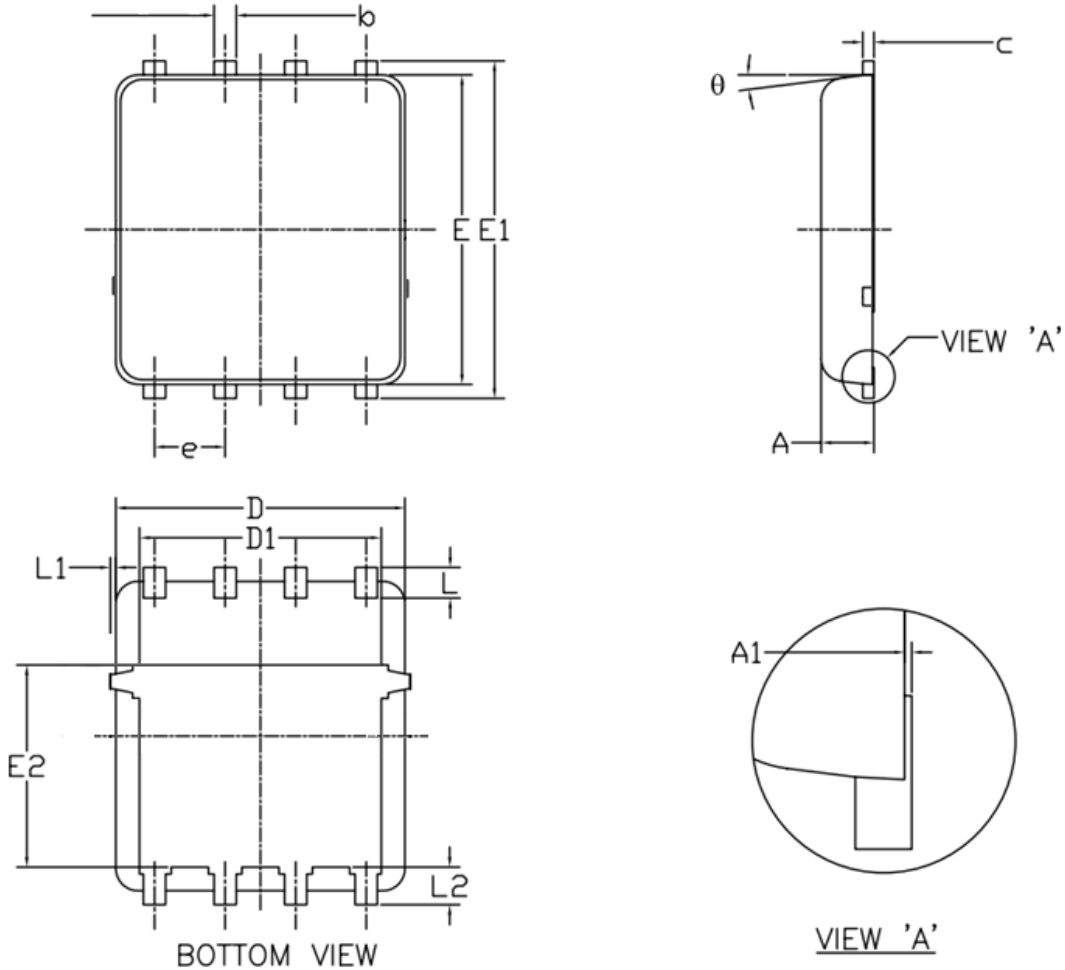

Figure 12. $R_{\theta JC}$ Transient Thermal Impedance

DFN5X6-8L Package Outline Dimensions



Symbol	Dimensions (unit:mm)			Symbol	Dimensions (unit:mm)		
	Min	Typ	Max		Min	Typ	Max
A	0.90	1.00	1.20	E1	5.90	6.10	6.35
A1	0.00	--	0.05	E2	3.38	3.58	3.92
b	0.30	0.40	0.51	e	1.27 BSC		
c	0.20	0.25	0.33	L	0.51	0.61	0.71
D	4.80	4.90	5.40	L1	--	--	0.15
D1	3.61	4.00	4.25	L2	0.41	0.51	0.61
E	5.65	5.80	6.06	θ	0°	--	12°