

**Features**

- Advanced high cell density Trench technology
- Super Low Gate Charge
- Excellent CdV/dt effect decline
- Green Device Available

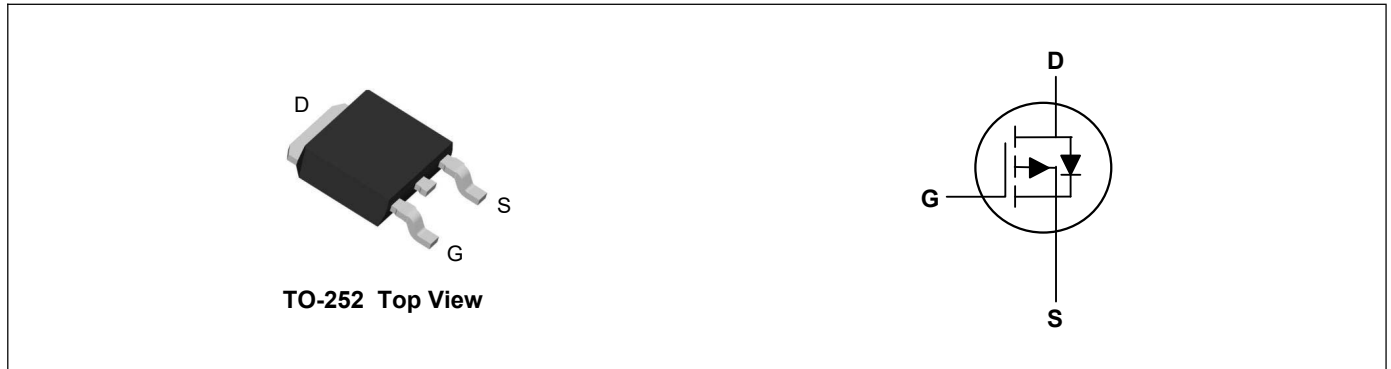
**Product Summary**



$V_{DS}$	-60	V
$I_D$	-13	A
$R_{DS(ON)}$ (at $V_{GS}=-10V$ )	90	m $\Omega$
$R_{DS(ON)}$ (at $V_{GS}=-4.5V$ )	115	m $\Omega$

**Applications**

- High Frequency Point-of-Load, Synchronous Buck Converter
- Networking DC-DC Power System
- Load Switch



**Absolute Maximum Ratings ( $T_A=25^{\circ}C$ , unless otherwise noted)**

Parameter	Symbol	Rating	Units
Drain-Source Voltage	$V_{DS}$	-60	V
Gate-Source Voltage	$V_{GS}$	$\pm 20$	V
Continuous Drain Current, $V_{GS}$ @ -10V <sup>1</sup>	$I_D@T_C=25^{\circ}C$	-13	A
Continuous Drain Current, $V_{GS}$ @ -10V <sup>1</sup>	$I_D@T_C=100^{\circ}C$	-8.3	A
Continuous Drain Current, $V_{GS}$ @ -10V <sup>1</sup>	$I_D@T_A=25^{\circ}C$	-3.3	A
Continuous Drain Current, $V_{GS}$ @ -10V <sup>1</sup>	$I_D@T_A=70^{\circ}C$	-2.7	A
Pulsed Drain Current <sup>2</sup>	$I_{DM}$	-26	A
Single Pulse Avalanche Energy <sup>3</sup>	EAS	29.8	mJ
Avalanche Current	$I_{AS}$	24.2	A
Total Power Dissipation <sup>4</sup>	$P_D@T_C=25^{\circ}C$	31.3	W
Total Power Dissipation <sup>4</sup>	$P_D@T_A=25^{\circ}C$	2	W
Storage Temperature Range	$T_{STG}$	-55 to 150	$^{\circ}C$
Operating Junction Temperature Range	$T_J$	-55 to 150	$^{\circ}C$

**Thermal Characteristics**

Parameter	Symbol	Typ	Max	Unit
Thermal Resistance Junction-Ambient <sup>1</sup>	$R_{\theta JA}$	---	62	$^{\circ}C/W$
Thermal Resistance Junction-Case <sup>1</sup>	$R_{\theta JC}$	---	4	$^{\circ}C/W$

**Electrical Characteristics (T<sub>J</sub>=25°C, unless otherwise noted)**

Parameter	Symbol	Conditions	Min	Typ	Max	Unit
Drain-Source Breakdown Voltage	BV <sub>DSS</sub>	V <sub>GS</sub> =0V, I <sub>D</sub> =-250uA	-60	---	---	V
BV <sub>DSS</sub> Temperature Coefficient	ΔBV <sub>DSS</sub> /ΔT <sub>J</sub>	Reference to 25°C, I <sub>D</sub> =-1mA	---	-0.023	---	V/°C
Static Drain-Source On-Resistance <sup>2</sup>	R <sub>DS(ON)</sub>	V <sub>GS</sub> =-10V, I <sub>D</sub> =-10A	---	---	90	mΩ
		V <sub>GS</sub> =-4.5V, I <sub>D</sub> =-5A	---	---	115	mΩ
Gate Threshold Voltage	V <sub>GS(th)</sub>	V <sub>GS</sub> =V <sub>DS</sub> , I <sub>D</sub> =-250uA	-1.0	---	-2.5	V
V <sub>GS(th)</sub> Temperature Coefficient	ΔV <sub>GS(th)</sub>		---	4.65	---	mV/°C
Drain-Source Leakage Current	I <sub>DSS</sub>	V <sub>DS</sub> =-48V, V <sub>GS</sub> =0V, T <sub>J</sub> =25°C	---	---	1	uA
		V <sub>DS</sub> =-48V, V <sub>GS</sub> =0V, T <sub>J</sub> =55°C	---	---	5	uA
Gate-Source Leakage Current	I <sub>GSS</sub>	V <sub>GS</sub> =±20V, V <sub>DS</sub> =0V	---	---	±100	nA
Forward Transconductance	g <sub>fs</sub>	V <sub>DS</sub> =-5V, I <sub>D</sub> =-4A	---	8.7	---	S
Gate Resistance	R <sub>g</sub>	V <sub>DS</sub> =0V, V <sub>GS</sub> =0V, f=1MHz	---	15	---	Ω
Total Gate Charge	Q <sub>g</sub>	V <sub>DS</sub> =-12V, V <sub>GS</sub> =-4.5V, I <sub>D</sub> =-6A	---	11.8	---	nC
Gate-Source Charge	Q <sub>gs</sub>		---	1.9	---	
Gate-Drain Charge	Q <sub>gd</sub>		---	6.5	---	
Turn-On Delay Time	T <sub>d(on)</sub>	V <sub>DD</sub> =-15V, V <sub>GS</sub> =-10V, R <sub>G</sub> =3.3Ω, I <sub>D</sub> =-1A	---	8.8	---	ns
Rise Time	T <sub>r</sub>		---	19.6	---	
Turn-Off Delay Time	T <sub>d(off)</sub>		---	47.2	---	
Fall Time	T <sub>f</sub>		---	9.6	---	
Input Capacitance	C <sub>iss</sub>	V <sub>DS</sub> =-15V, V <sub>GS</sub> =0V, f=1MHz	---	1080	---	pF
Output Capacitance	C <sub>oss</sub>		---	73	---	
Reverse Transfer Capacitance	C <sub>rss</sub>		---	50	---	

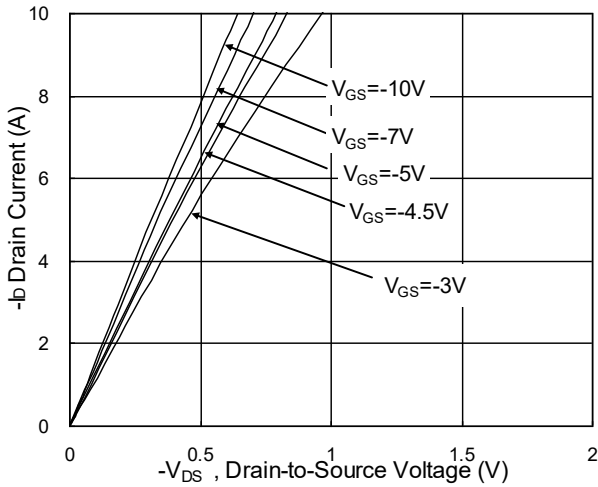
**Drain-Source Diode Characteristics**

Parameter	Symbol	Conditions	Min	Typ	Max	Unit
Continuous Source Current <sup>1,5</sup>	I <sub>S</sub>	V <sub>G</sub> =V <sub>D</sub> =0V, Force Current	---	---	-13	A
Pulsed Source Current <sup>2,5</sup>	I <sub>SM</sub>		---	---	-26	A
Diode Forward Voltage <sup>2</sup>	V <sub>SD</sub>	V <sub>GS</sub> =0V, I <sub>S</sub> =-1A, T <sub>J</sub> =25°C	---	---	-1	V

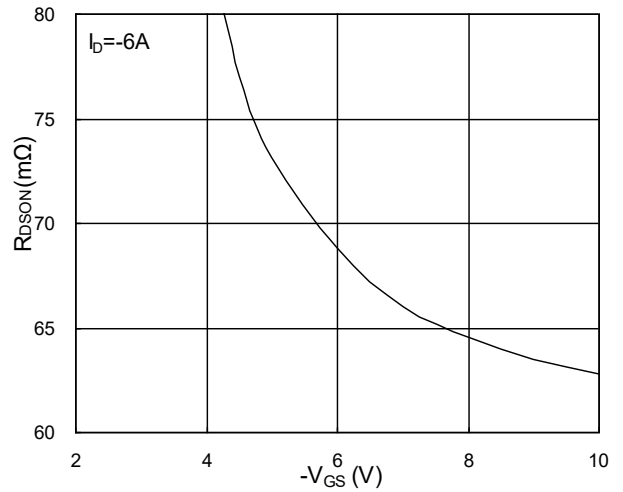
**Note:**

- 1.The data tested by surface mounted on a 1 inch<sup>2</sup> FR-4 board with 20Z copper.
- 2.The data tested by pulsed, pulse width ≤ 300us, duty cycle ≤ 2%
- 3.The EAS data shows Max. rating. The test condition is V<sub>DD</sub>=-25V, V<sub>GS</sub>=-10V, L=0.1mH
- 4.The power dissipation is limited by 150°C junction temperature
- 5.The data is theoretically the same as I<sub>D</sub> and I<sub>DM</sub>, in real applications, should be limited by total power dissipation.

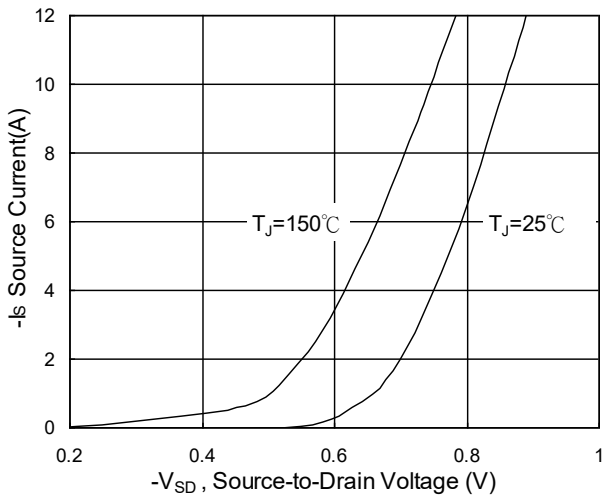
**Typical Characteristics**



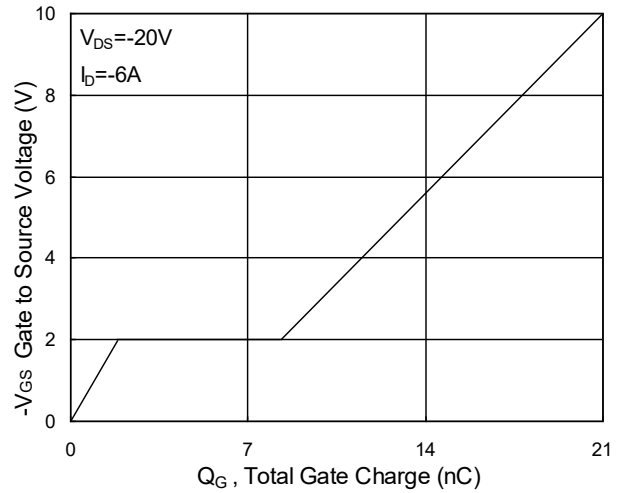
**Fig.1 Typical Output Characteristics**



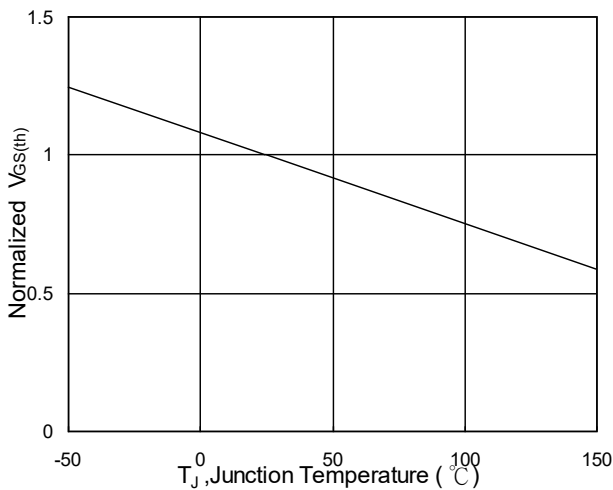
**Fig.2 On-Resistance v.s Gate-Source**



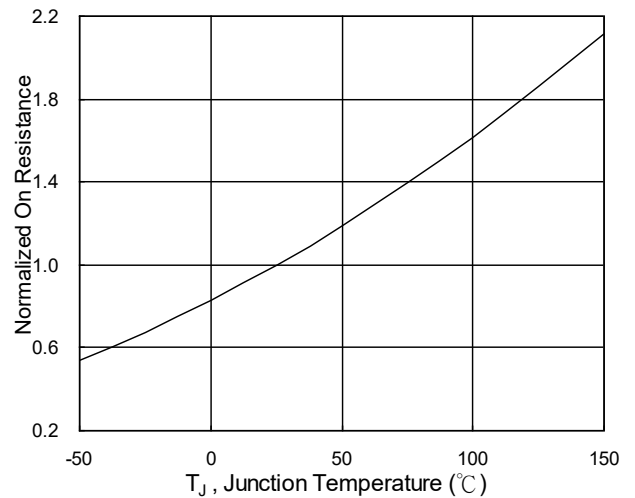
**Fig.3 Forward Characteristics of Reverse**



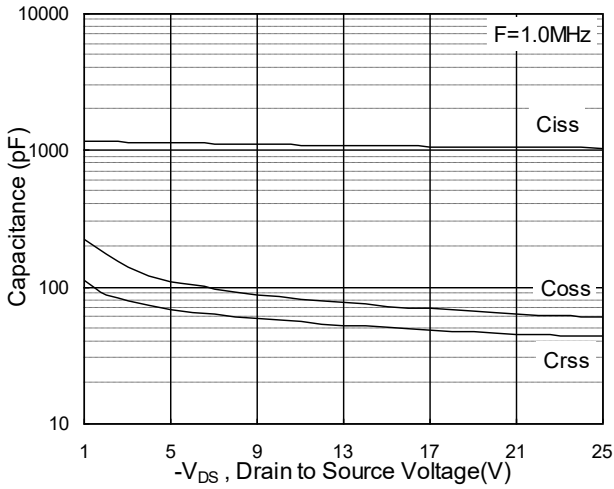
**Fig.4 Gate-Charge Characteristics**



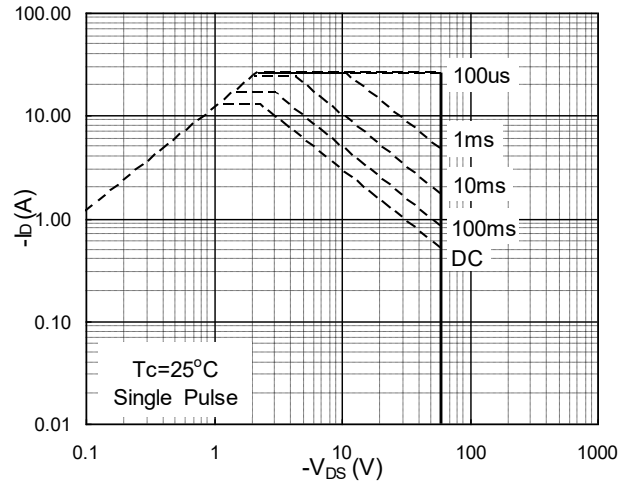
**Fig.5 Normalized V<sub>GS(th)</sub> v.s T<sub>J</sub>**



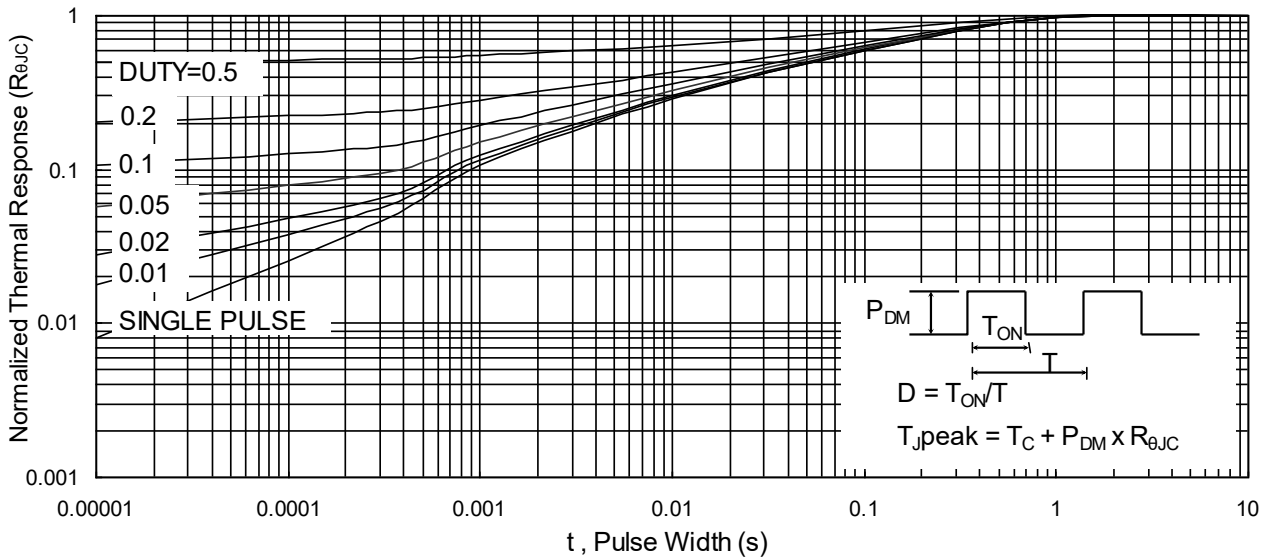
**Fig.6 Normalized R<sub>DSON</sub> v.s T<sub>J</sub>**



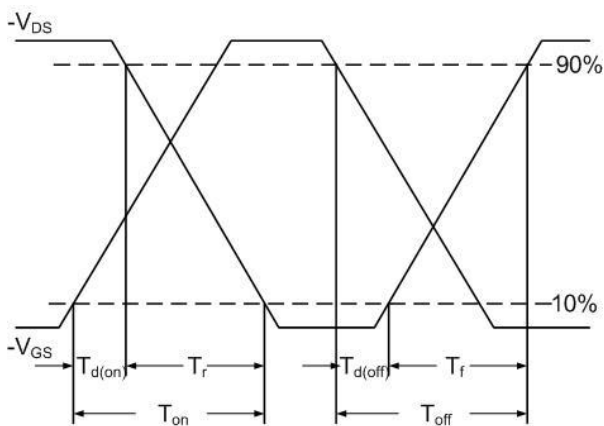
**Fig.7 Capacitance**



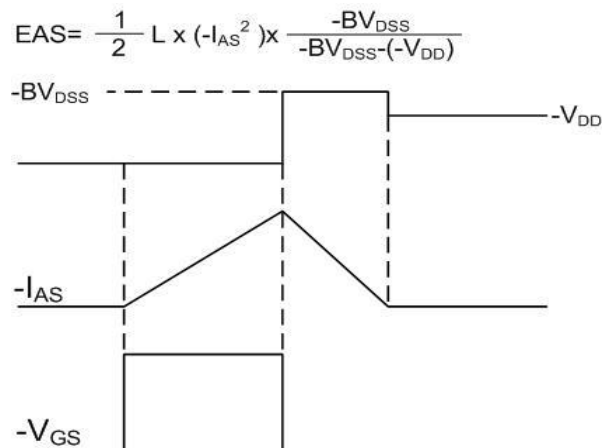
**Fig.8 Safe Operating Area**



**Fig.9 Normalized Maximum Transient Thermal Impedance**

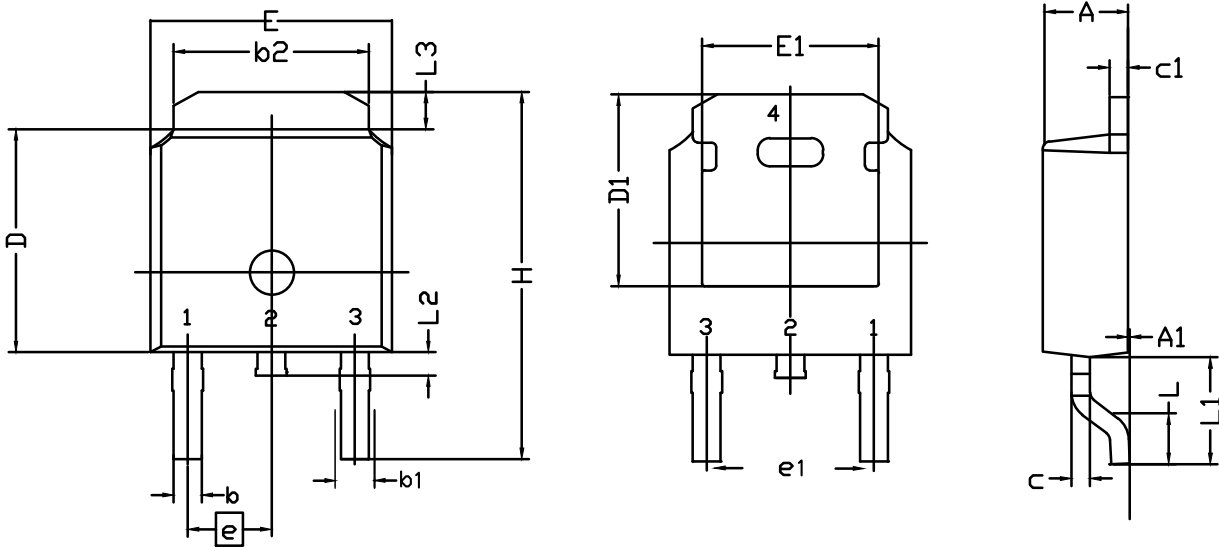


**Fig.10 Switching Time Waveform**



**Fig.11 Unclamped Inductive Switching Waveform**

**TO-252 Package Outline Dimensions**



Symbol	Dimensions (unit:mm)			Symbol	Dimensions (unit:mm)		
	Min	Typ	Max		Min	Typ	Max
<b>A</b>	2.20	2.30	2.38	<b>E</b>	6.40	6.60	6.731
<b>A<sub>1</sub></b>	0.00	0.10	0.20	<b>E<sub>1</sub></b>	4.40	--	--
<b>b</b>	0.64	0.76	0.89	<b>e</b>	2.286 BSC		
<b>b<sub>1</sub></b>	0.77	0.85	1.14	<b>e<sub>1</sub></b>	4.572 BSC		
<b>b<sub>2</sub></b>	5.00	5.33	5.46	<b>H</b>	9.40	10.00	10.40
<b>c</b>	0.458	0.508	0.610	<b>L</b>	1.40	1.52	1.77
<b>C<sub>1</sub></b>	0.458	0.508	0.620	<b>L<sub>1</sub></b>	--	2.743	--
<b>D</b>	5.98	6.10	6.223	<b>L<sub>2</sub></b>	0.60	0.80	1.01
<b>D<sub>1</sub></b>	5.20	5.25	5.38	<b>L<sub>3</sub></b>	0.90	1.06	1.25